

**Placer County Water Agency
Middle Fork American River Project
(FERC No. 2079)**

FINAL

**AQ 6 – FISH PASSAGE
TECHNICAL STUDY REPORT – 2008**



Placer County Water Agency
P.O. Box 6570
Auburn, CA 95604

July 2009

TABLE OF CONTENTS

	Page
1.0 Introduction	1
2.0 Study Objectives	1
3.0 Study Implementation	1
3.1. Study Elements Completed.....	1
3.2. Deviations from The Technical Study Plan	2
3.3. Outstanding Study Elements.....	2
3.4. Proposed Modification to Technical Study Plan	2
4.0 Extent of Study Area	3
5.0 Study Approach	3
5.1. Fish Passage Barriers in the Bypass and Peaking Reaches	4
5.1.1. 2005–2006 Field Mesohabitat Mapping	4
5.1.2. 2005 Aerial Video Review and 2007 Helicopter Fly-Over	5
5.1.3. 2007–2008 Field Visits	5
5.1.4. Barrier Classification and Data Collection.....	5
5.2. Fish Passage Barriers at Project Infrastructure.....	6
5.3. Fish Passage Barriers at River Tributary Confluences	6
5.4. Fish Passage Barriers at Reservoir Inlets.....	6
5.5. Quantitative and Qualitative Evaluation of Fish Passage.....	7
5.6. Species Distribution	8
6.0 Study Results.....	8
6.1. Key Findings	8
6.2. Fish Passage Barriers.....	10
6.2.1. Natural Fish Passage Barriers in the Bypass and Peaking Reaches	10
6.2.2. Fish Passage Barriers at Project Infrastructure	13
6.2.3. Fish Passage Barriers at Tributary Confluences.....	13
6.2.4. Fish Passage Barriers at Reservoir Inlets.....	14
6.3. Fish Passage at High Flows.....	15
6.4. Operational Fish Passage Barriers	15
6.5. Hydrodynamics Modeling.....	15
7.0 Literature Cited	16

List of Tables

- Table AQ 6-1. Tributaries Surveyed at Their Confluence with the Project Mainstem Rivers.
- Table AQ 6-2. Summary of Fish Species Observed during the 2007 Fish Population Sampling.
- Table AQ 6-3. Instream Channel Features that Present Potential Fish Passage Barriers.
- Table AQ 6-4. Infrastructure Facilities that Present Potential Fish Passage Barriers.
- Table AQ 6-5. Tributary Confluences that Present Potential Fish Passage Barriers.
- Table AQ 6-6. Reservoir Pool Inlets that Present Potential Fish Passage Barriers.

List of Figures

- Figure AQ 6-1. Fish Passage Objectives, Related Study Elements, and Reports.
- Figure AQ 6-2. Summary of Parameters Measured at Each Potential Barrier during 2007 Field Visits.
- Figure AQ 6-3. Trout and Minnow Swimming Speed Versus Time (12-inch fish).
- Figure AQ 6-4. Trout and Minnow Vertical and Horizontal Leaping Ability (12-inch fish).
- Figure AQ 6-5. Chute Water Velocity Versus Swimming Distance (12-inch fish).

List of Maps

- Map AQ 6-1. Fish Passage Barrier Survey Methodology.
- Map AQ 6-2. Fish Passage Barrier Locations and Frequency Overview Map.
- Map AQ 6-3. Fish Passage Barrier Locations and Frequency Lower Project Area.
- Map AQ 6-4. Fish Passage Barrier Locations and Frequency Upper Project Area.

List of Appendices

- Appendix A. Quantitative Barrier Assessment Data Sheet.
- Appendix B. Quantitative Barrier Evaluation Approach.
- Appendix C. Detailed Fish Passage Barrier Descriptions.
- Appendix D. Gradient Plots for Each of the Project Rivers.

1.0 INTRODUCTION

This report describes the fish passage study conducted by the Placer County Water Agency (PCWA) in accordance with the AQ 6 – Fish Passage Technical Study Plan (AQ 6 – TSP) for the Middle Fork American River Project (MFP or Project). The stakeholder-approved TSP was included in Supporting Document (SD) H of the Pre-Application Document (PAD) filed with the Federal Energy Regulatory Commission (FERC or Commission) on December 13, 2007 (PCWA 2007a).

Fish passage studies were conducted in the vicinity of the MFP during the summer and fall 2006–2008 with the objective of documenting the location and characteristics of upstream fish passage barriers (conditions that prohibit or impede upstream fish movement) in the bypass and peaking reaches, at tributary confluences, and at the inlets to Project reservoirs and diversion pools. Additionally, the study identified Project infrastructure facilities and operations that may affect fish passage.

The following provides a description of the study objectives, implementation progress, study area extent, study approach (field data collection and data analysis), and results.

2.0 STUDY OBJECTIVES

- Document the location, nature, and characteristics of fish barriers in bypass and peaking reaches, at tributary confluences, and at the inlets to Project reservoirs and diversion pools.
- Identify Project facilities and operations (e.g., diversion structures, instream flow releases, and reservoir water surface elevations) that may affect fish passage.

3.0 STUDY IMPLEMENTATION

Some study elements described in the AQ 6 – TSP (PCWA 2007a) were initiated in 2005–2006, prior to development of the AQ 6 – TSP as part of early physical habitat characterization studies of the MFP rivers (PCWA 2006; PCWA 2007b). All study elements of the AQ 6 – TSP (PCWA 2007a) will be completed by early 2009. Study elements that have been completed and outstanding study elements that remain to be completed, including any deviations from the AQ 6 – TSP, are discussed below. Figure AQ 6-1 shows the AQ 6 – TSP objectives and the study elements associated with each objective. The figure also shows where the information is documented.

3.1. STUDY ELEMENTS COMPLETED

The following fish passage study elements were completed in the summer and fall of 2007–2008:

- Identify the location and classify the type (e.g., fall, chute, cascade, critical riffle) of potential fish passage barriers in the bypass and peaking reaches using the mesohabitat mapping data collected during the 2005–2006 Physical Habitat

Characterization Study and aerial video (acquired in fall 2005) (PCWA 2006; PCWA 2007b).

- Identify the location and classify the type of potential tributary confluence or reservoir inlet fish passage barriers along the bypass and peaking river reaches and at Project reservoirs and diversions.
- Quantitatively calculate upstream fish passability at the potential barriers that were identified and classified in the field. Use field data collected during the base flow (low flow) period (e.g., falls height, chute velocity, plunge pool depth, etc.) to determine if barriers are passable, not passable, or potential barriers.
- Qualitatively assess whether the base flow upstream fish passage barriers have the potential to become passable at flows higher than base flow.

3.2. DEVIATIONS FROM THE TECHNICAL STUDY PLAN

Voluntary Enhancements

PCWA surveyed two inaccessible river reaches for passage barriers using low elevation helicopter fly-overs on the Middle Fork American River and the Rubicon River upstream from Ralston Afterbay.

PCWA revisited several potential barriers that were identified during the 2005–2006 mesohabitat mapping (PCWA 2006; PCWA 2007b) to collect the detailed measurements necessary for fish passage calculations.

PCWA surveyed several potential barriers that were identified during other field studies (e.g. fish population sampling), but were not located during the 2005–2006 mesohabitat field mapping and collected detailed measurements at the potential barriers to calculate fish passage.

Other Deviations

There were no other deviations from the AQ 6 – TSP.

3.3. OUTSTANDING STUDY ELEMENTS

The following study element will be completed in early 2009 during the draft review period of this report and then presented in the 2009 final version of the report:

- In collaboration with the Aquatic Technical Working Group (TWG), identify potential fish passage issues at Project diversion dams and identify if there are any barriers which require hydrodynamics modeling to assess fish passage at a range of flows other than base flow. Only barriers that prevent access to sections of river with important spawning or rearing habitat (as determined in collaboration with the Aquatic TWG) would be considered for modeling.

3.4. PROPOSED MODIFICATION TO TECHNICAL STUDY PLAN

No modifications are proposed to the AQ 6 – TSP.

4.0 EXTENT OF STUDY AREA

The study area includes the bypass reaches, peaking reach, and Project reservoirs and diversion pools. The specific fish passage study locations include the following:

- Potential fish barriers identified during the 2005–2006 Aquatic Habitat Characterization Study (PCWA 2006; PCWA 2007b).
- Tributary confluences within the bypass and peaking reaches including: Duncan Creek, South Fork Rubicon River, Pilot Creek, Long Canyon Creek, North Fork of the Middle Fork American River, Volcano Canyon Creek, Otter Creek, Canyon Creek, and several other small tributaries.
- Project reservoir dams (French Meadows, Hell Hole, Middle Fork Interbay, Ralston Afterbay) and the confluences of the rivers into the reservoirs (e.g., the confluences of Five Lakes Creek and the Rubicon River with Hell Hole Reservoir).
- Project diversion pool dams (Duncan Creek, South Fork Long Canyon, and North Fork Long Canyon) and the confluences of the streams into the diversion pools.
- Other Project infrastructure (stream gaging weirs, river road crossings, river tunnel crossings).

Some portions of the study area were very difficult to access due to rugged terrain. Field data were collected only in portions of the study area that were accessible. Inaccessible portions of the study area were assessed remotely, either with aerial video and/or with low elevation helicopter fly-overs (Map AQ 6-1).

5.0 STUDY APPROACH

A combination of data collected prior to development of the AQ 6 – TSP and data collected as part of the AQ 6 – TSP were used to identify and assess upstream fish passage barriers throughout the MFP study area.

- Data collected prior to the AQ 6 – TSP:
 - Helicopter aerial video of all MFP streams (acquired fall 2005);
 - Ground-based aquatic mesohabitat mapping data collected on approximately 36% of the length of MFP streams during 2005–2006 (PCWA 2006; PCWA 2007b); and
 - Visual observations during various helicopter fly-overs for Project reconnaissance and field work.
- Data collected in 2007–2008 as part of the AQ 6 – TSP:
 - Ground-based barrier mapping and barrier measurements at reservoir and diversion pool inlet streams;

- Ground-based barrier mapping and barrier measurements at tributary inflows to the bypass and peaking reach streams;
- Field visits and barrier measurements at Project infrastructure facilities;
- Field visits and barrier measurements at key natural barriers identified from: (1) the 2005–2006 mesohabitat mapping; (2) a review of the 2005 helicopter video; or (3) by other means such as during fish population or amphibian studies or from reviews of historical documents;
- Video mapping of barriers (2005 aerial video) in inaccessible portions of the Rubicon River and the Middle Fork American River upstream of Ralston Afterbay; and
- Low elevation helicopter fly-over barrier mapping and measurement estimation in inaccessible portions of the Rubicon River and the Middle Fork American River upstream of Ralston Afterbay.

Map AQ 6-1 shows the locations where each of the methods was used to identify barriers in the MFP study area.

Potential upstream fish passage barriers were classified as falls, chutes, or cascade types as defined by Powers and Orsborn (1985) or as critical riffles (Thompson 1972). Potential barriers were quantitatively evaluated for passage at base flow (low flow) from measurements collected during field visits using the analytical methods of Powers and Orsborn (1985) and Thompson (1972). Base flow passage barriers were qualitatively assessed in the field or from photographs for their potential to become passable at flows higher than base flow.

Potential fish passage barrier methods are organized and discussed below as follows: (1) bypass and peaking reaches; (2) Project infrastructure; (3) tributary confluences; and (4) reservoir inlets.

5.1. FISH PASSAGE BARRIERS IN THE BYPASS AND PEAKING REACHES

Potential passage barriers were identified and classified in the Project bypass and peaking reaches using the 2005–2006 field mesohabitat mapping data, a review of the 2005 helicopter video, 2007 low elevation helicopter fly-overs, and 2007–2008 site visits to barriers (Map AQ 6-1).

5.1.1. 2005–2006 Field Mesohabitat Mapping

Potential fish passage barriers were identified using the 2005–2006 mesohabitat mapping database (approximately 36% of the length of streams in the MFP were surveyed). Information collected at the barriers during the 2005–2006 surveys included fall height and plunge pool depth for falls and cascades. Generally, photographs were taken and spatial coordinates were collected at each barrier using a Global Positioning System (GPS).

5.1.2. 2005 Aerial Video Review and 2007 Helicopter Fly-Over

In inaccessible portions of the Middle Fork American and Rubicon rivers, the 2005 helicopter aerial video (taken during base flow) was reviewed to identify reaches with two categories of barrier density, low or high. Video was available for all rivers in the study area; however, the video was considered to be “low quality” on the smaller streams (Duncan Creek, Long Canyon Creek, North Fork Long Canyon Creek, South Fork Long Canyon Creek, Middle Fork American River above Middle Fork Interbay) that were either too small to be seen in the video clearly or obscured by vegetation, thus making accurate aerial assessment of barriers in these areas impractical. Map AQ 6-1 shows these locations.

During fall 2007, low elevation helicopter aerial surveys were conducted on the inaccessible sections of the large river bypass reaches upstream of Ralston Afterbay that coincided with the upstream distribution limit of hardhead and Sacramento pikeminnow (Map AQ 6-1). The Rubicon River from approximately river mile (RM) 3.0 to RM 15.0 and the Middle Fork American River from RM 26.0 to RM 33.0 were surveyed.

Photographs were taken of each barrier during the low elevation helicopter fly-over. Barrier dimensions were estimated from the photographs. Five accessible barriers were used to calibrate the estimated measurements made from photographs. These five barriers were assessed both from the helicopter and ground measurements. The GPS location was also recorded at each potential barrier.

5.1.3. 2007–2008 Field Visits

Barriers identified from the 2005–2006 field mesohabitat mapping (see above), from aerial video (see above), or identified during field work for other technical studies (e.g., fish population and amphibian sampling) that were particularly large or created by Project infrastructure or in critical locations that might preclude fish passage to large sections of river were visited in 2007–2008 to collect detailed measurements to more accurately evaluate upstream fish passage.

5.1.4. Barrier Classification and Data Collection

All potential barriers encountered during the 2005–2006 field mesohabitat mapping, during 2007–2008 field visits, and from the aerial video and the helicopter fly-over were characterized into the following categories:

- Falls, chutes, or cascades as defined by Powers and Orsborn (1985) or as critical riffles (Thompson 1972); and
- For the 2007–2008 data, cascade barriers were further subdivided into their component parts and recorded as a series of falls and/or chutes to estimate passage using the method of Powers and Orsborn (1985).

The barrier data collected during the 2007–2008 field visits are shown in Figure AQ 6-2. Appendix A shows a blank field form.

5.2. FISH PASSAGE BARRIERS AT PROJECT INFRASTRUCTURE

Each of the Project facilities that could potentially create passage barriers (dams, diversion facilities, tunnel stream crossings, road crossings, and gaging facilities) was visited. Detailed measurements of facilities were collected in the field and/or from engineering drawings. Upstream fish passage was then evaluated. The importance of the facility as a fish passage barrier was assessed, in part, based on the proximity of natural fish barriers upstream and/or downstream of the facility.

Reservoirs and diversion pools were assumed to be impediments to downstream fish passage for the purpose of this analysis. Downstream movement was assumed to be impeded (reduced or delayed) due to the diversion pool/dam structure, fish behavior, predation, and/or potentially entrainment (AQ 7 – Entrainment TSP (PCWA 2007c)). The potential effects of entrainment and downstream movement barriers will be assessed in the AQ 7 – Entrainment Technical Study Report (TSR).

5.3. FISH PASSAGE BARRIERS AT RIVER TRIBUTARY CONFLUENCES

At major river tributary confluences within the bypass and peaking river reaches, the portion of the tributary within the influence of the mainstem river's high to low flow water lines was surveyed for fish passage barriers. In addition, a minimum of 100 meters (typically much more) of the tributary above the high water line of the mainstream river was also surveyed. Surveys typically extended until an upstream fish passage barrier was encountered. The tributaries that were assessed at their confluence with the Project mainstem rivers are listed in Table AQ 6-1. Where potential passage barriers were identified within the influence of the mainstem river's water surface elevations, the elevation of the barrier was surveyed relative to the river main channel high water elevation.

5.4. FISH PASSAGE BARRIERS AT RESERVOIR INLETS

At each reservoir and diversion pool, significant tributaries (i.e., tributaries that provide rearing or spawning habitat) were surveyed for barriers from the low pool to high pool water mark. The location and elevation (in relation to the high water mark of the reservoir or diversion pool) of any potential barriers were surveyed. The following reservoir/diversion pool tributaries were surveyed:

- Duncan Creek (Duncan Creek Diversion Pool);
- South Fork Long Canyon Creek (South Fork Long Canyon Diversion Pool);
- North Fork Long Canyon Creek (North Fork Long Canyon Diversion Pool);
- Middle Fork American River (French Meadows Reservoir);
- Middle Fork American River (Middle Fork Interbay);

- Middle Fork American and Rubicon rivers (Ralston Afterbay); and
- Five Lakes Creek and Rubicon River (Hell Hole Reservoir).

5.5. QUANTITATIVE AND QUALITATIVE EVALUATION OF FISH PASSAGE

Upstream passage was evaluated quantitatively at base flows using the swimming and leaping capabilities of trout (particularly rainbow trout) and minnows/suckers (hardhead, Sacramento pikeminnow, Sacramento sucker). The general upstream fish passage assessment methodology outlined in Powers and Orsborn (1985) and Thompson (1972) was used to evaluate passage at potential vertical barriers, high velocity chutes, and/or critical riffles based on field measurements of the barriers. Appendix B provides a detailed discussion of the analysis approach and methods and the literature sources of the quantitative fish performance data. Because the MFP is located upstream of major anadromous fish passage barriers (Nimbus and Folsom dams), only the swimming capabilities of resident trout species were utilized.

Barriers were analyzed for passage by 12-inch (340 mm) trout and minnows/suckers (for a detailed explanation of fish size see Appendix B). The fish swimming speed versus time relationships used in the barrier evaluation are shown in Figure AQ 6-3. Corresponding vertical and horizontal leaping relationships based on the maximum (burst) swimming velocity were used to assess passage at vertical barriers (Figure AQ 6-4) and the prolonged swimming relationships were used to evaluate water velocity versus fish swimming distance for the chute and critical riffle passage analysis (Figure AQ 6-5). Water depth was also used to assess falls, chute, and critical riffle passage. The details are provided in Appendix B.

The biological parameters and criteria used in this analysis were intended to represent the overall populations of the target species (trout and minnows/suckers). It is important to note, however, that individual fish likely exhibit a wide range of swimming capability. The range of capabilities of trout are addressed, in part, by using “upper” and “lower” swimming velocities (Figure AQ 6-3). The ability of any single individual to navigate a potential barrier may be greater or lesser than the “average” individual used for this analysis. Also, this evaluation does not consider the cumulative effect of multiple upstream fish passage barriers located within a relatively short river reach. The cumulative effects on upstream passage likely exceed the effects of any single barrier.

As some potential barriers could only be observed visually from the air, these barriers were assessed qualitatively. If they appeared highly likely to be barriers, then they were classified as “potential barriers.” They were classified as “potential” only because barrier measurements were estimated and quantitative measurements to validate the estimates were not available.

The base flow potential barriers were also assessed qualitatively for fish passage at high flows by visually determining if there were obvious passage routes through or around the barrier that would be present at higher flows that would allow passage. This was only an approximate analysis. Section 3.3 outlines the Aquatic TWG collaborative

process if a particular barrier appears to require detailed quantitative assessment over a range of flows greater than base flow.

5.6. SPECIES DISTRIBUTION

Only resident fish species exist in the Project rivers and streams. A list of fish present in the Project rivers and streams, based on AQ 2 – Fish Population surveys (PCWA 2008), is presented in Table AQ 6-2. No anadromous species are present in the Project rivers. Adfluvial kokanee salmon were planted and are present in Hell Hole Reservoir and one kokanee salmon was also found in French Meadows Reservoir (although kokanee salmon are not actively planted in French Meadows Reservoir) (PCWA 2008). Kokanee migrate upstream from reservoirs into streams to spawn in the fall. Rainbow and brown trout are present throughout the Project area, except that brown trout are not present in Long Canyon Creek (including North and South Fork Long Canyon creeks). The upstream distribution limit of hardhead and pikeminnow was assessed by snorkeling during summer 2008 (PCWA 2009) and was approximately 0.5 miles above Ralston Afterbay on the Middle Fork American River and approximately 5.4 miles (hardhead) and 7.6 miles (pikeminnow) upstream of Ralston Afterbay on the Rubicon River. The Sacramento sucker distribution roughly followed the minnow distribution, however one Sacramento sucker was observed farther upstream in the Rubicon River near Ellicott Bridge (RM 20.9) during sampling in 2007 (PCWA 2008).

6.0 STUDY RESULTS

6.1. KEY FINDINGS

Fish Passage Barriers in the Bypass and Peaking Reaches

- Many natural and non-Project (e.g., Tunnel Chute) barriers to upstream fish movement were present throughout the Project peaking and bypass reaches. Barriers to upstream movement were frequent in nearly all river reaches; little opportunity existed for fish to move long distances upstream in the Project rivers and streams due to the presence of barriers.

Fish Passage Barriers at Project Infrastructure

- MFP facilities (4 large dams, 3 small diversion structures, 1 tunnel stream crossing, 1 road crossings, 3 gage weirs) created additional barriers to upstream fish movement. However, these barriers were located in reaches that contain natural barriers and typically did not preclude fish from accessing large sections of river due to the nearby presence of natural and non-Project barriers.

Fish Passage Barriers at Tributary Confluences

- Nearly all of the tributaries to the MFP bypass and peaking reaches that were surveyed had natural barriers near their confluence with the bypass and peaking reach rivers that precluded upstream fish movement into the tributaries (16 of the 18 evaluated).

- Two tributaries to the peaking reach provided accessible habitat for fish: North Fork of the Middle Fork American River and Otter Creek (approximately the lower 1.5 miles of Otter Creek).
- Project operations did not affect access to the bypass and peaking reach tributary streams, except that a critical riffle temporary barrier could potentially occur at the Otter Creek confluence when flows are very low in Otter Creek, daily peaking flow in the peaking reach is low (e.g., <200–300 cfs), and the arrangement of the channel on the delta is such that very shallow flows are created.

Fish Passage Barriers at Reservoir Inlets

- Three of the four reservoirs and two of the three diversions pools had river/stream inlets that were barrier free and the reservoir or diversion pool elevations did not affect upstream fish passage.
 - Several natural barriers existed in the channels of the Rubicon River and Five Lakes Creek below the high water mark of Hell Hole Reservoir. On both streams, however, there were natural barriers immediately upstream of the reservoir high water mark that precluded upstream access to the rivers, regardless of the reservoir water surface elevation.
 - The South Fork Long Canyon Diversion Pool had a critical riffle barrier where a gravel delta formed at the inlet. When the diversion pool was not full the critical riffle was exposed and created a potential barrier to upstream movement from out of the diversion pool area into the stream.

Upstream Barrier Limits to Hardhead and Pikeminnow Distribution

- The upstream limit to hardhead and pikeminnow on the Middle Fork American River was a large natural barrier complex 0.5 miles above Ralston Afterbay. The upstream distribution limit on the Rubicon River above Ralston Afterbay was a series of natural barriers along several miles of river (RM 3.4 to RM 8.2). The hardhead distribution ended at a natural waterfall at RM 6.0 and the Sacramento pikeminnow distribution approximately ended at a large natural waterfall at RM 8.2.

Hydrodynamics Modeling

- No fish passage barriers were identified where further study appeared warranted to understand passage over a wider range of flows (e.g., flow sensitive barriers that prevent access to large sections of river with important spawning or rearing habitat).

6.2. FISH PASSAGE BARRIERS

Potential fish passage barriers were categorized into four groups: (1) natural barriers in the bypass and peaking reaches; (2) Project infrastructure barriers; (3) barriers at tributary confluences; and (4) junction barriers at reservoir inlets (Tables AQ 6-3, 6-4, 6-5, and 6-6 respectively). Map AQ 6-2 shows all of the individual passage barriers identified and the inferred abundance of natural barriers in reaches mapped only from aerial imagery and/or helicopter fly-overs. Maps AQ 6-3 and AQ 6-4 show enlargements of Map AQ 6-2 for the lower and upper Project area, respectively. Pictures and details of many of the barriers are available in Appendix C.

6.2.1. Natural Fish Passage Barriers in the Bypass and Peaking Reaches

Many natural and non-Project barriers to upstream fish movement were present throughout the Project peaking and bypass reaches. Typically, little opportunity existed for fish to travel long distances in an upstream direction in the Project rivers and streams due to the presence of these barriers (Table AQ 6-3 and Figure AQ 6-2).

Natural barriers were most abundant in the smaller streams (Duncan Creek, Long Canyon Creek, North Fork Long Canyon Creek, and South Fork Long Canyon Creek) and the upstream, higher gradient reaches of the large rivers (Middle Fork American River upstream of Middle Fork Interbay and Rubicon River between Long Canyon Creek and Deer Creek). Appendix D shows gradient plots for each of the Project rivers.

Natural barriers were less abundant in the lower gradient sections of the larger rivers: (1) Middle Fork American River in the peaking reach and in an isolated section of river within the Ralston Afterbay to Middle Fork Interbay reach (RM 26.5–RM 33.3); and (2) Rubicon River from below Hell Hole Dam to Deer Creek (RM 24.7–RM 28.8) and from near Long Canyon Creek to Ralston Afterbay (RM 0.7–RM 3.4) (Appendix D).

Peaking Reach

The peaking reach from Ralston Afterbay to Folsom Reservoir was segmented by two large, non-Project related barriers: Ruck-a-Chucky Falls and Tunnel Chute (Map AQ 6-3 and Table AQ 6-3). The lower half of the peaking reach was currently barrier free from Folsom Reservoir upstream to Ruck-a-Chucky Falls (14.7 miles). Within this section of river, there were historically two barriers that currently do not exist. The proposed Auburn Dam site bypass tunnel created an upstream fish passage barrier until just recently (Map AQ 6-3). Construction of the tunnel and cofferdam began in the late 1960's. In fall 2007, the tunnel was sealed and the river was returned to the historical channel. Historically, there was also at least a partial natural barrier at Murderer's Bar (approximately RM 2.0) that was removed by gold miners prior to 1882 (Yoshiyama, et al. 1996). This location still had a narrow high velocity chute, but from our analysis it appeared to be passable.

Ruck-a-Chucky Falls is a large multi-falls barrier that appears to be natural, but was apparently created in the 1940's by a landslide at the location where the Army Corps of Engineers was doing initial work for a proposed sediment dam (B. Deitchman, Pers.

Comm.). Upstream of Ruck-a-Chucky Falls (RM 10.7), there has an approximately 12-mile section of barrier free river to Tunnel Chute (RM 22.9).

Tunnel Chute was created by miners in the 1880's to bypass the Horseshoe Bar section of river. The 18-foot drop at the chute created an upstream barrier that prevents fish from accessing upstream habitat. At very high flows (>10,000 cfs) tunnel chute can completely fill with water and cause excess water to flow through the historic natural channel at horseshoe bar and potentially allow fish passage around tunnel chute. Information regarding the magnitude of flow necessary to "water" the horseshoe bar channel is currently being developed as part of the AQ1 – Instream Flow TSP (PCWA 2007d) and will be reported in the summer of 2009. Within the Ruck-a-Chucky Falls to Tunnel Chute section of river, tributary habitat was accessible in Otter Creek.

Approximately two miles upstream of Tunnel Chute, Ralston Afterbay Dam created an upstream barrier and downstream impediment to fish movement. In the reach between Tunnel Chute and Ralston Afterbay Dam, tributary habitat was accessible in the North Fork of the Middle Fork American River.

Large Rivers Above Ralston Afterbay (Rubicon River and Middle Fork American River)

Numerous natural fish passage barriers were present on both the Rubicon and Middle Fork American rivers between Ralston Afterbay and the headwater reservoirs (French Meadows and Hell Hole reservoirs) (Map AQ 6-3, Map AQ 6-4, and Table AQ 6-3). Barriers were abundant in sections of the rivers where the canyon was relatively narrow and the channel gradient was steep (>2%) and they were less frequent in sections of river where the canyon was wider and the gradient was lower (<2%) (PCWA (2006) Rosgen stream classifications and Appendix D).

Rubicon River. There was a 3-mile section of the Rubicon River from Ralston Afterbay (RM 0.6) upstream to the Long Canyon Creek confluence (RM 3.6) that was low gradient (<2%) and contained few potential barriers. From the Long Canyon Creek confluence upstream to approximately Deer Creek (RM 25.0), the gradient was steeper (>2%) and there were many passage barriers. From Deer Creek upstream to the debris from the Hell Hole Dam failure, there were few barriers (lower gradient channel (<2%)). The Hell Hole Dam failure in December 1964 left an approximately 1+ mile impassable section of river that flows subsurface through the remaining debris. Immediately below the dam, there was a short section (0.3 miles) of continuous surface flow (i.e., upstream of the subsurface flow section). Hell Hole Dam was both an upstream passage barrier and a downstream passage impediment.

Middle Fork American River. The Middle Fork American River had several impassable barriers in a locally narrow, steep gradient (>2%) section of river at MF26.6, 0.5 miles upstream of Ralston Afterbay. Upstream from the barriers, there was a relatively long, lower gradient, section of river (approximately 6 miles) where no barriers were identified (to near Brushy Creek at MF33.0). In the upper 2 miles of the reach up to the base of Middle Fork Interbay Dam, the canyon was narrow and steep gradient

(>2%) and abundant natural barriers were observed in the aerial video and various helicopter fly-overs.

Middle Fork Interbay created an upstream passage barrier and a downstream passage impediment. From Middle Fork Interbay (RM 35.6) upstream to French Meadows Reservoir, the relatively narrow canyon and steep gradient (>2%) channel contained abundant natural barriers. The first impassable barrier in the reach was immediately upstream of Middle Fork Interbay. French Meadows Reservoir was an upstream passage barrier and a downstream passage impediment. The river upstream of French Meadows Reservoir was barrier free for approximately 8 miles (RM 57.9).

Passage Barriers that Limit Hardhead and Pikeminnow Distribution. Barriers on both the Middle Fork American and Rubicon rivers prohibited large scale upstream movement of fish upstream of Ralston Afterbay. On the Middle Fork American River there was a significant series of large barriers beginning 0.5 miles upstream of Ralston Afterbay. Only 0.5 miles of river was accessible to fish moving upstream out of Ralston Afterbay. No hardhead or pikeminnow were found above these barriers (PCWA 2009).

On the Rubicon River upstream of Ralston Afterbay, a series of potential barriers (e.g., partial blockage of upstream passage) and barriers exists upstream of RM 3.4 (Table AQ 6-3). Many of the barriers were inaccessible and assessed qualitatively as potential barriers from the low elevation helicopter flyover. Several of the largest barriers were accessed on the ground. The first large barrier (5+ feet falls) that was rated impassable occurred at RM 6.0, approximately 5.4 miles upstream from Ralston Afterbay (Map AQ 6-3 and Table AQ 6-3). Pikeminnow, but no hardhead, were found above this barrier. Another large, impassable falls barrier was located at RM 8.2 with approximately 8+ feet of drop (7.4 miles upstream of Ralston Afterbay). A small number of pikeminnow were observed immediately upstream of this barrier, but not farther upstream (PCWA 2009).

Historically, steelhead and Chinook salmon reportedly ascended the Rubicon River as far as a natural barrier approximately “4 to 5 miles” upstream of the Middle Fork American River confluence (Yoshiyama, et al. 1996). This may be the barrier identified at RM 6.0 (just upstream of Pilot Creek).

Within the accessible segment of the Rubicon River (below RM 6.0), there were two tributaries, Long Canyon Creek and Pilot Creek. Both of these tributaries, however, had impassable barriers within 0.2 miles or less upstream of their confluences with the Rubicon River (Map AQ 6-3 and Table AQ 6-4).

Small Streams

Impassable natural barriers were common in all of the small streams (Duncan Creek, Long Canyon Creek, North Fork Long Canyon Creek, and South Fork Long Canyon Creek). In particular, the lower portions of both Duncan and Long Canyon creeks were particularly steep gradient (>4%) and confined. These sections of river were inaccessible, but numerous natural barriers were observed in the aerial video and during various helicopter fly-overs (Project reconnaissance and field work). The

accessible portions of the small streams that were lower gradient (>2 and <4%) and mapped during fieldwork, also contained many natural barriers (Figure AQ 6-4 and Table AQ 6-3).

6.2.2. Fish Passage Barriers at Project Infrastructure

Twelve Project infrastructure features created fish passage barriers in the Project streams and rivers (Table AQ 6-4, Map AQ 6-3, and Map AQ 6-4). Seven dams and diversions (Ralston Afterbay, Middle Fork Interbay, French Meadows Dam, Hell Hole Dam, Duncan Creek Diversion, North Fork Long Canyon Diversion, and South Fork Long Canyon Diversion) created barriers to upstream passage and were also impediments to downstream movement. Of the remaining five infrastructure passage barriers, three were flow gaging weirs (gages upstream of Duncan Creek Diversion and below French Meadows Dam and the abandoned gaging weir below Middle Fork Interbay). The two other infrastructure passage barriers were the Hell Hole to Middle Fork Tunnel crossing on North Fork Long Canyon Creek and the campground road crossing on South Fork Long Canyon Creek just upstream of the South Fork Long Canyon Diversion. Pictures of all the infrastructure barriers are shown in Appendix C.

In all cases, natural or non-Project barriers existed above and/or below the Project infrastructure barriers (Maps AQ 6-3 and AQ 6-4). As a result, Project infrastructure isolated little additional river or stream habitat beyond that already segmented due to natural upstream passage barriers. For example, on South Fork Long Canyon Creek there was a very large natural falls and chute combination barrier just downstream of the South Fork Long Canyon Diversion. Upstream of the diversion there was a long section of ephemeral stream during the summer where the creek passed through an old debris flow channel and created a natural fish passage barrier.

6.2.3. Fish Passage Barriers at Tributary Confluences

Peaking Reach

Eleven tributaries to the peaking reach were surveyed for barriers near their confluence with the Middle Fork American River (Table AQ 6-1, Table AQ 6-5, and Map AQ 6-2). Of the 11 tributaries surveyed, nine were steep gradient and had natural passage barriers just upstream of their confluence with the Middle Fork American River. As discussed previously, the North Fork of the Middle Fork American River and Otter Creek were the only tributaries that provided a significant amount of accessible tributary habitat for fish.

The lowermost 1.5 miles of Otter Creek was accessible from the mainstem river. A potential temporary critical riffle existed at the confluence of Otter Creek and Middle Fork American River at a small gravel delta where the tributary stream entered the river. During summer hydropower peaking flows (e.g., 1,000 cfs) the stage height of the Middle Fork American River covered most of the riffle (some was still exposed) and Otter Creek was easily accessible. At lower flows (e.g., <200–300 cfs), the delta was mostly exposed and shallow water on the delta face could potentially create a

temporary impassable barrier to larger fish if flow in Otter Creek was low. During our visits, the flow in Otter Creek was sufficient and the arrangement of the channel on the delta was such that passage was possible. No other fish passage barriers were observed in the approximately 1.5 miles of lower Otter Creek that was surveyed. An impassable chute existed at RM 1.5.

The North Fork of the Middle Fork American River was accessible from the mainstem Middle Fork American River. Qualitative assessment and observations during other filed studies suggest that the North Fork of the Middle Fork American River is without barriers for more than 2 miles upstream from the confluence.

Large Rivers Above Ralston Afterbay (Rubicon River and Middle Fork American River)

Six tributaries to the Middle Fork American River, Rubicon River, and Long Canyon Creek bypass reaches upstream of Ralston Afterbay were surveyed for barriers (Brushy Canyon Creek, Duncan Creek, Long Canyon Creek, Wallace Creek, Pilot Creek, and South Fork Rubicon River) (Table AQ 6-1, Table AQ 6-5, and Map AQ 6-2). In all cases, the tributaries had impassable barriers at or just upstream of their confluence with the mainstem. Long Canyon Creek provided the longest section of habitat upstream of the confluence (0.2 miles) with the Rubicon River. Impassable barriers, however, prevented further upstream fish passage.

6.2.4. Fish Passage Barriers at Reservoir Inlets

All major inlets to reservoirs and diversion pools were free from natural or reservoir created fish passage barriers except the Hell Hole Reservoir inlet and the South Fork Long Canyon Diversion inlet (Table AQ 6-6 and Map AQ 6-4).

At the inlet to Hell Hole Reservoir there were five natural channel barriers in the Rubicon River below the Hell Hole Reservoir high water mark (i.e., river barriers when the reservoir was not at full pool); however, there were also three natural impassable barriers in the Rubicon River just upstream of the reservoir (above the high water mark) that precluded upstream passage in the river regardless of reservoir elevations. The elevations of the barriers below the full pool water mark are shown in Table AQ 6-6 and the plan view map locations are shown in Map AQ 6-4. The barriers located in the Rubicon River upstream of the reservoir were very near the reservoir confluence (Table AQ 6-3). Upstream of these barriers, there appeared to be at least 0.6 miles of the Rubicon River free of barriers. Detailed surveys were not conducted farther upstream.

There was also a potential natural stream barrier on Five Lakes Creek approximately 13 to 14 feet below the Hell Hole Reservoir high water mark. Upstream from the high water mark, there was a section of creek free of barriers. Detailed surveys were not conducted within this section of creek, but from the aerial imagery, topography maps, and various helicopter fly-overs there appears to be less than 0.7 miles of creek that would be barrier free. Upstream of this, the topography is very steep and numerous barriers (falls) are assumed to exist.

The South Fork Long Canyon Diversion pool created a gravel delta at the inlet. When the diversion pool was full, fish passage out of the diversion pool was possible. When the diversion pool was not full a critical riffle was exposed on the gravel delta that created a potential barrier to upstream movement from out of the diversion pool area into the stream. It should be noted that when the diversion pool was not full, it was when water was not being diverted (summer/fall) and there was essentially a small shallow pool in the bottom of the diversion pool area.

6.3. FISH PASSAGE AT HIGH FLOWS

Fish passage was qualitatively assessed to determine if barriers at base flow might become passable at higher flows. In most cases, the mechanism that would have allowed impassable barriers to become passable at higher flows was the inundation of high flow channels, which would provide an alternate route around barriers. Many of the natural base flow barriers were evaluated to potentially become passable at much higher flows than base flow (e.g., spring runoff flows) when high flow channels around the barriers would become inundated (Table AQ 6-3). In most cases, however, it appeared that at moderately higher flows than summer base flow, most of the falls and chute type barriers would not become more passable as the falls heights would remain nearly the same and the water velocities in the chutes would increase. Section 3.3 outlines the process to quantitatively assess passage at range of flows higher than base flow if key barriers are identified (also see below).

6.4. OPERATIONAL FISH PASSAGE BARRIERS

There were no Project operations identified regarding the magnitude or timing of flow releases or reservoir water surface elevations that appeared to be creating fish passage barriers or affecting passage at natural barriers, except for those discussed previously at Hell Hole Reservoir and South Fork Long Canyon Diversion (section 6.2.4) and the Otter Creek confluence (section 6.2.3).

6.5. HYDRODYNAMICS MODELING

We did not identify any potential fish passage barriers, natural or Project infrastructure, which required quantitative hydrodynamics modeling to better understand passage over a wide range flows. Nearly all of the barriers observed in the Project rivers and streams were fall type barriers. In most cases, these types of barriers appeared to be insensitive to moderate flow alteration, i.e., the limiting factor, fall height, would change little without large changes in flow (note: some small falls could be washed out at moderately high flow). Also, frequently, no single barrier or small barrier precluded fish from accessing large sections of river that contained important spawning or rearing habitat. For example, the barriers on the Middle Fork American River and Rubicon River above Ralston Afterbay that limited the upstream distribution of minnows were a series of large falls barriers that were very insensitive to flow (i.e., were clearly barriers over a wide range of flows). Hydrodynamic modeling of these barriers would be challenging and provide limited additional management information.

7.0 LITERATURE CITED

- Berry, C.R., and R. Pimentel. 1985. Swimming Performances of Three Rare Colorado River Fishes. *Transactions of the American Fisheries Society* 114:397-402.
- Beamish, F.W.H. 1978. Swimming Capacity. In *Fish Physiology*, vol. 7. (eds. W. S. Hoar and D. J. Randall), pp. 101-187. Academic Press, New York.
- Brett, J. R. and Glass, N. R. 1973. Metabolic rates and critical swimming speeds of sockeye salmon (*Oncorhynchus nerka*) in relation to size and temperature. *J. Fish. Res. Bd Can.* 30, 379-387.
- Hawkins, D.K. and T.P. Quinn. 1996. Critical Swimming Velocity and Associated Morphology of Juvenile Coastal Cutthroat Trout (*Oncorhynchus clarki clarki*), and Steelhead Trout (*Oncorhynchus mykiss*), and their Hybrids. *Can. J. Fish. Aquat. Sci.* 53:1487-1496.
- Jain, K.E., J.C. Hamilton, and A.P. Farrell. 1997. Use of Ramp Velocity Test to Measure Critical Swimming Speed in Rainbow Trout (*Oncorhynchus mykiss*). *Comp. Biochem. Physiol.* 117A:441-444.
- Kondratieff, M. C., and C. A. Myrick. 2006. How high can brook trout jump? A laboratory evaluation of brook trout jumping performance. *Transaction of the American Fisheries Society.* 135: 361-370.
- Myrick, C.A. and J.J. Cech, Jr. 2000. Swimming performances of four California stream fishes: temperature effects. *Env. Biol. Fish.* 58:289-295.
- Placer County Water Agency (PCWA). 2006. Middle Fork American River Hydroelectric Project (FERC 2079) 2006 Aquatic Habitat Characterization Study Plan. September 8, 2006.
- PCWA. 2007a. AQ 6 – Fish Passage TSP. Placer County Water Agency Middle Fork American River Project (FERC Project No. 2079), PAD. SD H, Appendix A. Submitted to FERC on December 13, 2007.
- PCWA. 2007b. DRAFT 2006 Physical Habitat Characterization Study Report. PCWA Middle Fork American River Project (FERC Project No. 2079), PAD. SD G, Book 2 of 2. Submitted to FERC on December 13, 2007.
- PCWA. 2007c. AQ 7 – Fish Entrainment Technical Study Plan (TSP). PCWA Middle Fork American River Project (FERC Project No. 2079), PAD. SD H, Appendix A. Submitted to FERC on December 13, 2007.
- PCWA. 2007d. AQ1 – Instream Flow TSP. Placer County Water Agency Middle Fork American River Project (FERC Project No. 2079), PAD. SD H, Appendix A. Submitted to FERC on December 13, 2007.
- PCWA. 2008. AQ 2 – Fish Population Technical Study Report (TSR) – 2007. PCWA Middle Fork American River Project (FERC Project No. 2079). March 2008.

- PCWA. 2009. DRAFT AQ 2 – Fish Population Technical Study Report (TSR) – 2008. PCWA Middle Fork American River Project (FERC Project No. 2079). January 2009.
- Powers, P. D. and J. F. Orsborn. 1985. Analysis of Barriers to Upstream Migration: An Investigation of the Physical and Biological Conditions Affecting Fish Passage Success at Culverts and Waterfalls. BPA Report No. DOE/BP-36523-1.
- Reiser, D. W. and R. T. Peacock. 1985. A Technique for Assessing Upstream Fish Passage Problems at Small-Scale Hydropower Developments. Symposium on Small Hydropower and Fisheries, May 1-3. 1985.
- Thompson, K. 1972. Determining Stream Flows for Fish Life in Pacific Northwest River Basins Commission Instream Flow Requirements Workshop, March 15-16. 1972.
- United States Department of Fish and Wildlife Service (USFWS). 2008 FishXing Software and Learning Systems for Fish Passage through Culverts. Accessed 2008. <http://www.stream.fs.fed.us/fishxing/beta.html>
- Videler, J. J. 1993. Fish Swimming. London, Chapman & Hall.
- Yoshiyama, R. M., E. R. Gerstung, F. W. Fisher, and P. B. Moyle. 1996. Historical and present distribution of Chinook salmon in the Central Valley drainage of California. Sierra Nevada Ecosystem Project: Final Report to Congress, vol. III. Davis, CA: University of California, Center for Water and Wildland Resources.

Personal Communication

Bill Deitchman, Auburn State Recreation Area, Personal Communication, May 2008.

TABLES

Table AQ 6-1. Tributaries Surveyed at Their Confluence with the Project Mainstem Rivers.

River and River Mile on Mainstem River	Surveyed Tributary
Middle Fork American River	
RM 6.4	American Canyon Creek
RM 9.3	Gas Canyon Creek
	Todd Valley Creek
RM 11.0	Canyon Creek
RM 14.1	Otter Creek
RM 17.0	Jesse Creek
RM 18.1	Pond Creek
RM 18.5	Dardanelles Creek
RM 19.5	Snyder Canyon Creek
RM 21.0	Volcano Canyon Creek
RM 24.1	North Fork of the Middle Fork American River
RM 30.4	Brushy Canyon Creek
RM 39.7	Duncan Creek
Rubicon River	
RM 3.5	Long Canyon Creek
RM 5.2	Pilot Creek
RM 22.6	South Fork Rubicon River
Long Canyon Creek	
RM 5.6	Wallace Creek

Table AQ 6-2. Summary of Fish Species Observed¹ during the 2007–2008 Fish Population Sampling (●).

Study Site	Fish Species ²														
	RBT	BNT	HH	SPM	MXD	SS	SCULP	SD	CAR	SMB	GSUN	KOK	TCB	LKT	WCF
Middle Fork American River Downstream of Ralston Afterbay															
Fish MF4.8	●	●			●	●	●								
MFAR at RM 4.8				●		●	●								
Fish MF14.1	●	●				●	●								
Otter Creek at MF14.1	●		●	●	●	●	●		●						
Gas Canyon	●	●					●								
Fish MF23.5	●	●			●										
MFAR at RM 23.5	●	●	●	●		●	●								
Middle Fork American River from Middle Fork Interbay to Ralston Afterbay															
Fish MF26.2	●	●	●	●	●	●	●	●	●	●					
MFAR at RM26.2	●	●	●	●	●	●	●	●	●	●					
MFAR at RM26.6	●	●													
MFAR at RM29.4	●	●													
Middle Fork American River Upstream of Middle Fork Interbay															
Fish MF36.2	●	●													
Fish MF44.7	●	●													
Fish MF51.8	●	●													
Rubicon River															
Rubicon River RM 0.0–0.5	●		●	●	●	●	●	●	●	●					
Rubicon at RM 3.5	●	●	●	●	●					●					
Fish R 3.5	●	●		●	●	●	●	●	●	●					
Rubicon River at RM 5.2	●	●	●	●	●					●					
Rubicon River at RM 6.2	●	●	●	●						●					
Rubicon River at RM 8.0	●	●		●						●					
Rubicon River at RM 9.9	●	●								●					
Rubicon River at RM 14.3	●	●								●					
Fish R20.9	●	●				●									
Fish R25.7	●	●													
Fish R36.2	●	●							●						
Long Canyon Creek															
LC at RM 0.2	●	●	●	●						●					
Fish LC9.0	●														
North Fork Long Canyon Creek															
Fish NFLC1.9	●														
Fish NFLC3.8	●														
NFLC RM 3.6–5.0	●														

**Table AQ 6-2. Summary of Fish Species Observed¹ during the 2007–2008 Fish Population Sampling (●)
(continued).**

Study Site	Fish Species ²														
	RBT	BNT	HH	SPM	MXD	SS	SCULP	SD	CAR	SMB	GSUN	KOK	TCB	LKT	WCF
South Fork Long Canyon Creek															
Fish SFLC2.3	●														
Fish SFLC4.2	●														
SFLC RM 5.7– 9.4	●														
Duncan Creek															
Fish D6.3	●	●													
Fish D8.3	●	●													
Fish D9.0	●	●													
Fish D10.0	●	●													
Duncan Creek RM9.0 - 13.6	●	●													
North Fork of the Middle Fork American River															
NFMF at RM 0.2	●	●	●	●					●						
Fish NFMF2.3	●			●		●	●	●	●						
North Fork American River															
Fish NF18.4	●	●				●	●								
Fish NF31.3	●			●	●	●	●			●	●				
NF at RM 31.3	●		●	●		●	●			●	●				●
Fish NF53.7	●			●	●	●	●	●	●						
Diversion Pools															
NFLC	dry														
SFLC	●														
Duncan	●	●													
Reservoirs															
Ralston	●	●	●	●		●									
Interbay	●	●													
French Meadows	●	●										●	●		
Hell Hole	●	●				●						●	●	●	

¹Refer to PCWA (2008) for details on the site locations, sampling methods, and additional results of the 2007AQ 2 - Fish Population studies.

²Species: RBT = Rainbow Trout; BNT = Brown Trout; HH = Hardhead; SPM = Sacramento Pike Minnow; MXD = Mixed Minnow; SS = Sacramento Sucker; SCULP = Sculpin; SD = Speckled Dace; CAR = California Roach; SMB = Smallmouth Bass; GSUN = Green Sunfish; KOK = Kokanee; TCB = Tui Chub; LKT = Lake Trout; WCF = White Catfish

³RM = River Mile

Table AQ 6-3. Instream Channel Features that Present Potential Fish Passage Barriers.

Barrier ID	River Mile	Barrier Assessment ¹	Barrier Class	Physical Characteristics at Low Flows				Passable at Low Flows		Barrier Limitation ⁷	Passable at Higher Flows	Comments
				Height ² (ft)	Horizontal Distance or Length (ft) (Measured or Calculated) ³	Depth ⁴ (ft)	Water Velocity ⁵ (ft/s)	Trout	Minnows ⁶			
Middle Fork American River Downstream of Ralston Afterbay												
Ruck-a-Chucky Falls - MF10.7a	MF10.7	2007 Survey	Falls	18.0	1.0	4.0	-	NO	NO	FH	NO	Complex falls system.
Ruck-a-Chucky Falls - MF10.7b	MF10.7	2007 Survey	Falls	3.0	1.0	3.0	-	NO	NO	FH	NO	Complex falls system.
Ruck-a-Chucky Falls - MF10.7c	MF10.7	2007 Survey	Falls	8.0	1.0	1.0	-	NO	NO	FH	NO	Complex falls system.
Ruck-a-Chucky Falls - MF10.7d	MF10.7	2007 Survey	Falls	4.0	1.0	1.0	-	NO	NO	FH	NO	Complex falls system.
Ruck-a-Chucky Falls - MF10.7e	MF10.7	2007 Survey	Falls	6.0	1.0	1.0	-	NO	NO	FH	NO	Complex falls system.
Ruck-a-Chucky Falls - MF10.7f	MF10.7	2007 Survey	Falls	3.0	1.0	2.0	-	NO	NO	FH	NO	Complex falls system.
Ruck-a-Chucky Falls - MF10.7g	MF10.7	2007 Survey	Falls	3.0	1.0	3.0	-	NO	NO	FH	NO	Complex falls system.
Tunnel Chute - MF22.9b	MF22.9	2007 Survey	Falls	2.0	3.5	1.5	3.5	NO	NO	FH	NO	
Tunnel Chute - MF22.9e	MF22.9	2007 Survey	Falls	2.3	5.1	1.9	4.0	NO	NO	FH	NO	
Middle Fork American River from Ralston Afterbay to Middle Fork Interbay												
Plunge Pool above Ralston Afterbay MF26.4	MF26.4	2007 Survey	Falls	8.5	8.8	4.5	4.1	NO	NO	FH	NO	
Instream Barrier Qual - MF26.6a	MF26.6	Aerial Survey	Falls	-	-	-	-	NO	NO	FH	NO	Evaluated from helicopter and photos.
Instream Barrier Qual - MF26.6b	MF26.6	Aerial Survey	Falls	-	-	-	-	NO	NA	FH	NO	Evaluated from helicopter and photos.
Instream Barrier Qual - MF26.6c	MF26.6	Aerial Survey	Falls	-	-	-	-	NO	NA	FH	NO	Evaluated from helicopter and photos.
Instream Barrier Qual - MF26.6d	MF26.6	Aerial Survey	Falls	-	-	-	-	Potential	NA	FH	Potential	Evaluated from helicopter and photos.
Instream Barrier Qual - MF26.6e	MF26.6	Aerial Survey	Falls	-	-	-	-	Potential	NA	FH	Potential	Evaluated from helicopter and photos.
Middle Fork American River Upstream of Middle Fork Interbay												
Plunge Pool above Middle Fork Interbay - MF36.3	MF36.3	2007 Survey	Falls	4.0	3.0	-	-	NO	NA	FH	NO	
Instream Barrier - MF44.6	MF44.6	2006 Survey	Falls	3.5	1.0	1.8	-	NO	NA	FH	Potential	
Instream Barrier - MF44.7	MF44.7	2006 Survey	Falls	3.5	1.0	1.3	-	NO	NA	FH	Potential	
Instream Barrier - MF44.8	MF44.8	2006 Survey	Falls	2.2	1.0	3.6	-	NO	NA	FH	Potential	
Instream Barrier - MF44.9a	MF44.9	2006 Survey	Falls	4.0	1.0	6.0	-	NO	NA	FH	Potential	
Instream Barrier - MF44.9b	MF44.9	2006 Survey	Falls	6.0	1.0	3.0	-	NO	NA	FH	Potential	
Instream Barrier - MF45.2a	MF45.2	2006 Survey	Falls	3.0	1.0	3.8	-	NO	NA	FH	Potential	
Instream Barrier - MF45.2b	MF45.2	2006 Survey	Falls	6.0	1.0	3.3	-	NO	NA	FH	Potential	
Instream Barrier - MF45.3	MF45.3	2006 Survey	Falls	7.0	1.0	2.0	-	NO	NA	FH	Potential	
Instream Barrier - MF45.4	MF45.4	2006 Survey	Falls	3.0	1.0	2.5	-	NO	NA	FH	Potential	
Instream Barrier - MF57.9	MF57.9	2008 Survey	Falls	9.4	2.5	1.4	-	NO	NA	FH LD	NO	8 miles upstream of French Meadows Reservoir.
Rubicon River												
Cascade below Long Canyon Confluence - R3.4a	R3.4	2007 Survey	Falls	2.2	2.4	3.6	1.9	NO	NO	FH	Potential	
Cascade below Long Canyon Confluence - R3.4b	R3.4	2007 Survey	Falls	2.1	0.9	1.3	3.1	Potential	NO	FH	Potential	
Instream Barrier Qual - R3.9	R3.9	Aerial Survey	Falls	-	-	-	-	Potential	Potential	FH	Potential	Evaluated from helicopter and photos.
Instream Barrier Qual - R4.2	R4.2	Aerial Survey	Falls	-	-	-	-	Potential	Potential	FH	Potential	Evaluated from helicopter and photos.
Instream Barrier Qual - R4.5	R4.5	Aerial Survey	Falls	-	-	-	-	Potential	Potential	FH	Potential	Evaluated from helicopter and photos.
Instream Barrier Qual - R4.6	R4.6	Aerial Survey	Falls	-	-	-	-	Potential	Potential	FH	Potential	Evaluated from helicopter and photos.
Instream Barrier Qual - R4.7	R4.7	Aerial Survey	Falls	-	-	-	-	Potential	Potential	FH	Potential	Evaluated from helicopter and photos.
Instream Barrier Qual - R5.1	R5.1	Aerial Survey	Falls	-	-	-	-	Potential	Potential	FH	Potential	Evaluated from helicopter and photos.
Instream Barrier Qual - R6.0	R6.0	Aerial Survey	Falls	5.0	-	-	-	NO	NO	FH	Potential	Evaluated from helicopter and photos.
Instream Barrier Qual - R6.1	R6.1	Aerial Survey	Falls	-	-	-	-	Potential	Potential	FH	Potential	Evaluated from helicopter and photos.
Instream Barrier Qual - R7.7b	R7.7	Aerial Survey	Falls	-	-	-	-	Potential	Potential	FH	Potential	Evaluated from helicopter and photos.
Instream Barrier Qual - R7.8	R7.8	Aerial Survey	Falls	-	-	-	-	Potential	Potential	FH	Potential	Evaluated from helicopter and photos.
Instream Barrier Qual - R7.9	R7.9	Aerial Survey	Chute	-	-	-	-	Potential	Potential	CV	Potential	Evaluated from helicopter and photos.
Instream Barrier Qual - R8.0	R8.0	Aerial Survey	Falls	-	-	-	-	Potential	Potential	FH	Potential	Evaluated from helicopter and photos.

Table AQ 6-3. Instream Channel Features that Present Potential Fish Passage Barriers (continued).

Barrier ID	River Mile	Barrier Assessment ¹	Barrier Class	Physical Characteristics at Low Flows				Passable at Low Flows		Barrier Limitation ⁷	Passable at Higher Flows	Comments
				Height ² (ft)	Horizontal Distance or Length (ft) (Measured or Calculated) ³	Depth ⁴ (ft)	Water Velocity ⁵ (ft/s)	Trout	Minnows ⁶			
Rubicon River												
Instream Barrier Qual - R8.2	R8.2	Aerial Survey	Falls	8.0	-	-	-	NO	NO	FH	Potential	Evaluated from helicopter and photos.
Instream Barrier Qual - R8.7	R8.7	Aerial Survey	Falls	-	-	-	-	Potential	NA	FH	Potential	Evaluated from helicopter and photos.
Instream Barrier Qual - R8.8	R8.8	Aerial Survey	Falls	-	-	-	-	Potential	NA	FH	Potential	Evaluated from helicopter and photos.
Instream Barrier Qual - R8.9	R8.9	Aerial Survey	Falls	-	-	-	-	Potential	NA	FH	Potential	Evaluated from helicopter and photos.
Instream Barrier Qual - R9.7	R9.7	Aerial Survey	Falls	-	-	-	-	Potential	NA	FH	Potential	Evaluated from helicopter and photos.
Instream Barrier Qual - R9.8	R9.8	Aerial Survey	Falls	-	-	-	-	Potential	NA	FH	Potential	Evaluated from helicopter and photos.
Instream Barrier Qual - R10.2	R10.2	Aerial Survey	Falls	-	-	-	-	Potential	NA	FH	Potential	Evaluated from helicopter and photos.
Instream Barrier Qual - R10.7	R10.7	Aerial Survey	Falls	-	-	-	-	Potential	NA	FH	Potential	Evaluated from helicopter and photos.
Instream Barrier Qual - R10.8	R10.8	Aerial Survey	Falls	-	-	-	-	Potential	NA	FH	Potential	Evaluated from helicopter and photos.
Instream Barrier Qual - R11.2a	R11.2	Aerial Survey	Falls	-	-	-	-	Potential	NA	FH	Potential	Evaluated from helicopter and photos.
Instream Barrier Qual - R11.2b	R11.2	Aerial Survey	Falls	-	-	-	-	Potential	NA	FH	Potential	Evaluated from helicopter and photos.
Instream Barrier Qual - R11.8	R11.8	Aerial Survey	Falls	-	-	-	-	Potential	NA	FH	Potential	Evaluated from helicopter and photos.
Instream Barrier Qual - R12.2	R12.2	Aerial Survey	Falls	-	-	-	-	Potential	NA	FH	Potential	Evaluated from helicopter and photos.
Instream Barrier Qual - R12.6	R12.6	Aerial Survey	Falls	-	-	-	-	Potential	NA	FH	Potential	Evaluated from helicopter and photos.
Instream Barrier Qual - R13.0	R13.0	Aerial Survey	Falls	-	-	-	-	Potential	NA	FH	Potential	Evaluated from helicopter and photos.
Instream Barrier Qual - R13.2	R13.2	Aerial Survey	Falls	-	-	-	-	Potential	NA	FH	Potential	Evaluated from helicopter and photos.
Instream Barrier - R14.2	R14.2	2006 Survey	Falls	6.0	1.0	2.9	-	NO	NA	FH	Potential	
Instream Barrier Qual - R14.6	R14.6	Aerial Survey	Falls	-	-	-	-	Potential	NA	FH	Potential	Evaluated from helicopter and photos.
Instream Barrier Qual - R14.9	R14.9	Aerial Survey	Falls	-	-	-	-	Potential	NA	FH	Potential	Evaluated from helicopter and photos.
Instream Barrier - R15.0a	R15.0	2006 Survey	Chute	-	5.0	0.3	-	Potential	NA	CV	Potential	Bedrock sheet.
Instream Barrier - R15.0b	R15.0	2006 Survey	Falls	4.0	1.0	7.0	-	NO	NA	FH	Potential	
Instream Barrier Qual - R15.3	R15.3	Aerial Survey	Falls	-	-	-	-	NO	NA	FH	NO	Evaluated from helicopter and photos. Large falls and bedrock sheet.
Sedimentation from Dam Failure Event - R28.9	R28.9	Aerial Survey	Dry	-	-	-	-	NO	NA	RD	Potential	
Instream Barrier - R35.8c	R35.8	2007 Survey	Falls	8.0	-	0.0	-	NO	NA	FH PD	No	Above Hell Hole Reservoir high water mark.
Instream Barrier - R35.8d	R35.8	2007 Survey	Chute	-	8.0	1.0	-	NO	NA	PD	No	Above Hell Hole Reservoir high water mark.
Instream Barrier - R35.8e	R35.8	2007 Survey	Falls	10.0	-	8.0	-	NO	NA	FH	No	Above Hell Hole Reservoir high water mark.
Long Canyon Creek												
Instream Barrier - LC0.2b	LC0.2	2006 Survey	Falls	3.0	1.0	6.6	-	NO	NO	FH	Potential	
Instream Barrier - LC0.2c	LC0.2	2006 Survey	Falls	4.5	1.0	0.5	-	NO	NA	FH PD	Potential	
Instream Barrier - LC6.0	LC6.0	2006 Survey	Falls	7.0	1.0	3.5	-	NO	NA	FH	Potential	
Instream Barrier - LC6.2	LC6.2	2006 Survey	Falls	3.0	1.0	0.4	-	NO	NA	FH PD	Potential	
Instream Barrier - LC6.4	LC6.4	2006 Survey	Falls	5.0	1.0	0.5	-	NO	NA	FH PD	Potential	
Instream Barrier - LC6.5	LC6.5	2006 Survey	Falls	4.0	1.0	2.0	-	NO	NA	FH	Potential	
Instream Barrier - LC6.7	LC6.7	2006 Survey	Falls	3.0	1.0	0.5	-	NO	NA	FH PD	Potential	
Instream Barrier - LC6.8	LC6.8	2006 Survey	Falls	3.5	1.0	0.1	-	NO	NA	FH PD	Potential	
Instream Barrier - LC6.9a	LC6.9	2006 Survey	Falls	4.0	1.0	2.0	-	NO	NA	FH FH	Potential	
Instream Barrier - LC6.9b	LC6.9	2006 Survey	Falls	4.5	1.0	1.5	-	NO	NA	FH PD	Potential	
Instream Barrier - LC8.2a	LC8.2	2006 Survey	Falls	3.0	1.0	0.7	-	NO	NA	FH	Potential	
Instream Barrier - LC8.2b	LC8.2	2006 Survey	Falls	4.0	1.0	4.0	-	NO	NA	FH	Potential	
Instream Barrier - LC9.1a	LC9.1	2006 Survey	Falls	4.0	1.0	4.0	-	NO	NA	FH	Potential	
Instream Barrier - LC9.1b	LC9.1	2006 Survey	Falls	5.0	1.0	3.0	-	NO	NA	FH	Potential	
Instream Barrier - LC9.8	LC9.8	2006 Survey	Falls	4.0	1.0	2.2	-	NO	NA	FH	Potential	
Instream Barrier - LC11.0	LC11.0	2006 Survey	Falls	9.0	1.0	6.5	-	NO	NA	FH	Potential	
Instream Barrier - LC11.2a	LC11.2	2006 Survey	Chute	-	-	-	-	NO	NA	CD CV	Potential	
Instream Barrier - LC11.2b	LC11.2	2006 Survey	Falls	2.2	1.0	1.0	-	NO	NA	FH	Potential	
Instream Barrier - LC11.4	LC11.4	2006 Survey	Falls	3.0	1.0	0.3	-	NO	NA	FH PD	Potential	

Table AQ 6-3. Instream Channel Features that Present Potential Fish Passage Barriers (continued).

Barrier ID	River Mile	Barrier Assessment ¹	Barrier Class	Physical Characteristics at Low Flows				Passable at Low Flows		Barrier Limitation ⁷	Passable at Higher Flows	Comments
				Height ² (ft)	Horizontal Distance or Length (ft) (Measured or Calculated) ³	Depth ⁴ (ft)	Water Velocity ⁵ (ft/s)	Trout	Minnows ⁶			
North Fork Long Canyon Creek												
Instream Barrier - NFLC0.1	NFLC0.1	2006 Survey	Falls	6.0	1.0	2.2	-	NO	NA	FH	Potential	
Instream Barrier - NFLC0.7	NFLC0.7	2006 Survey	Falls	2.4	1.0	0.1	-	NO	NA	FH PD	Potential	
Instream Barrier - NFLC0.9	NFLC0.9	2006 Survey	Falls	2.5	1.0	0.8	-	NO	NA	FH PD	Potential	
Instream Barrier - NFLC1.6	NFLC1.6	2006 Survey	Falls	3.0	1.0	0.7	-	NO	NA	FH PD	Potential	
Instream Barrier - NFLC1.7	NFLC1.7	2006 Survey	Falls	2.0	1.0	1.4	-	Potential	NA	FH	Potential	Total barrier at low flows.
Instream Barrier - NFLC4.0	NFLC4.0	2006 Survey	Falls	2.9	1.0	1.4	-	NO	NA	FH	Potential	
South Fork Long Canyon Creek												
Instream Barrier - SFLC0.7	SFLC0.7	2006 Survey	Falls	6.5	1.0	4.5	-	NO	NA	FH	Potential	10' drop over 22' feet of cascades.
Instream Barrier - SFLC0.8	SFLC0.8	2006 Survey	Chute	-	13.0	-	-	NO	NA	CD CV	Potential	Bedrock sheet. Evaluated from photos.
Instream Barrier - SFLC1.4a	SFLC1.4	2006 Survey	Falls	2.0	1.0	-	-	Potential	NA	FH	Potential	Total barrier at low flow.
Instream Barrier - SFLC1.4b	SFLC1.4	2006 Survey	Falls	2.0	1.0	-	-	Potential	NA	FH	Potential	Total barrier at low flow.
Plunge Pool below South Fork Long Canyon Diversion Dam - SFLC3.2a	SFLC3.2	2007 Survey	Chute	-	25.0	0.1	6.8	NO	NA	CD CV	NO	Downstream start of large barrier sequence.
Plunge Pool below South Fork Long Canyon Diversion Dam - SFLC3.2b	SFLC3.2	2007 Survey	Falls	3.3	1.6	2.1	6.8	NO	NA	FH LD	NO	
Plunge Pool below South Fork Long Canyon Diversion Dam - SFLC3.2c	SFLC3.2	2007 Survey	Chute	-	18.0	0.1	6.8	NO	NA	CD CV	NO	Chute flows directly into lower falls - no plunge pool.
Plunge Pool below South Fork Long Canyon Diversion Dam - SFLC3.2d	SFLC3.2	2007 Survey	Falls	1.4	0.8	1.4	1.5	Potential	NA	FH LD	NO	Upstream-most measured barrier in sequence - smaller chutes and falls continue upstream.
Natural dewatered section above South Fork Long Canyon Diversion Dam	SFLC3.6-4.0	2006 Survey	Dry	-	-	-	-	NO	NA	RD	Yes	Recent landslide event has created subterranean flow
Duncan Creek												
Instream Barrier - D4.4	D4.4	2006 Survey	Falls	2.7	1.0	1.7	-	NO	NA	FH	Potential	
Instream Barrier - D6.3	D6.3	2006 Survey	Falls	2.5	1.0	2.4	-	NO	NA	FH	Potential	
Instream Barrier - D6.4	D6.4	2006 Survey	Falls	2.0	1.0	3.0	-	Potential	NA	FH	Potential	
Instream Barrier - D6.8	D6.8	2006 Survey	Falls	1.5	1.0	1.6	-	Potential	NA	FH	Potential	
Instream Barrier - D7.2	D7.2	2006 Survey	Falls	1.7	1.0	0.9	-	Potential	NA	FH PD	Potential	
Instream Barrier - D8.2	D8.2	2006 Survey	Falls	-	-	-	-	Potential	NA	FH	Potential	
Instream Barrier - D8.4a	D8.4	2006 Survey	Falls	2.0	1.0	1.0	-	Potential	NA	FH	Potential	
Instream Barrier - D8.4b	D8.4	2006 Survey	Falls	2.0	1.0	1.1	-	Potential	NA	FH	Potential	
Instream Barrier - D9.0a	D9.0	2006 Survey	Falls	2.5	1.0	1.2	-	NO	NA	FH	Potential	
Bedrock section above Duncan Diversion Dam - D9.0b	D9.0	2007 Survey	Chute	-	8.0	0.2	4.0	Potential	NA	CD	Potential	Measurement taken at bottom chute in a series of 3 similar chutes.
Bedrock section above Duncan Diversion Dam - D9.1a	D9.1	2007 Survey	Chute	-	4.7	0.2	5.0	Potential	NA	CD	Potential	
Bedrock section above Duncan Diversion Dam - D9.1b	D9.1	2007 Survey	Falls	3.6	3.9	0.1	1.9	NO	NA	FH	Potential	Falls spill onto bedrock. Falls are split, measurements are from the channel with the most flow.

¹Barriers visited during 2007 barrier surveys were assessed following the methods of Powers and Orsborn (1985) and Thompson (1972). Barriers visited in 2006 were assessed following the 2006 Aquatic Mesohabitat Mapping Technical Study Plan (PCWA 2006).

²Height of vertical barrier for falls.

³Horizontal leap distance required to clear falls or swimming length of chutes. The horizontal distance of falls was not assessed during the 2006 Aquatic Mapping. In these cases, the fish length applied to the leaping equation was used for the horizontal distance.

⁴Plunge pool depth for falls, depth of water in chutes, or average depth within critical riffles.

⁵Velocity at crest of falls, water velocity in chutes, or average velocity within critical riffles.

⁶"Minnows" include hardhead, Sacramento pikeminnow, and Sacramento sucker. Distribution was assumed to be limited to the Middle Fork American River downstream of the impassable barrier at river mile 26.6 and the Rubicon River downstream of the impassable barrier at river mile 8.2.

⁷RD = riffle depth; RV = riffle velocity; PD = plunge pool depth; LD = landing depth; LV = landing velocity; FH = falls height; CV = chute velocity and length; CD = chute depth; Turb = turbidity.

Table AQ 6-4. Infrastructure Facilities that Present Potential Fish Passage Barriers.

Barrier ID	River Mile	Barrier Class	Barrier Assessment ¹	Physical Characteristics at Low Flows				Passable at Low Flows		Barrier Limitation ⁷	Passable at Higher Flow	Comments
				Height ² (ft)	Horizontal Distance or Length (ft) (Measured or Calculated) ³	Depth ⁴ (ft)	Water Velocity ⁵ (ft/s)	Trout	Minnows ⁶			
Middle Fork American River Downstream of Ralston Afterbay												
Ralston Afterbay Dam	MF24.7	Falls	2007 Survey	89.0	-	-	-	NO	NO	FH	NO	
Middle Fork American River from Ralston Afterbay to Middle Fork Interbay												
Abandoned Weir below Middle Fork Interbay	MF35.5	Falls	2007 Survey	6.7	7.3	1.6	2.2	NO	NA	FH Turb	NO	Deterioration of the weir allows some water to flow through.
Middle Fork Interbay Dam	MF35.6	Falls	2007 Survey	70.5	0.1	6.0	0.5	NO	NA	FH LD	NO	Measurements taken at skirt along the base of the dam.
Middle Fork American River Upstream of Middle Fork Interbay												
Weir with Gage below French Meadows Dam	MF46.6	Falls	2007 Survey	0.1	4.8	2.8	-	Potential	NA	FH	YES	Observed at high flows, weir inundated.
French Meadows Dam	MF47.2	Falls	2007 Survey	231.0	-	-	-	NO	NA	FH	NO	
Rubicon River												
Hell Hole Dam	R30.5	Falls	2007 Survey	410.0	-	-	-	NO	NA	FH	NO	
North Fork Long Canyon Creek												
River Crossing of Hell Hole - Middle Fork Tunnel	NFLC0.6	Falls	2007 Survey	9.3	0.1	1.0	0.4	NO	NA	FH LD	NO	Minimal water spilling over top of barrier.
Cascade below weir below Diversion Dam - NFLC3.1	NFLC3.1	Falls	2007 Survey	3.8	1.3	0.6	1.3	NO	NA	FH PD LD	Potential	Cascade covered by cement from weir. Measurements made on accessible features.
North Fork Long Canyon Diversion Dam	NFLC3.1	Falls	2007 Survey	10.0	-	-	-	NO	NA	FH	NO	
South Fork Long Canyon Creek												
South Fork Long Canyon Diversion Dam	SFLC3.3	Falls	2007 Survey	27.0	-	-	-	NO	NA	FH	NO	
Road Crossing to Campground above Diversion Dam	SFLC3.5	Chute	2006 Survey	-	15.0	0.1	-	NO	NA	CD	NO	
Duncan Creek												
Duncan Diversion Dam	D8.6	Falls	2007 Survey	32.0	-	-	-	NO	NA	FH	NO	
Weir at Gage above Duncan Diversion Dam	D8.8	Falls	2007 Survey	0.7	1.2	1.3	1.0	Potential	NA	FH	YES	

¹Barriers visited during 2007 barrier surveys were assessed following the methods of Powers and Orsborn (1985) and Thompson (1972). Barriers visited in 2006 were assessed following the 2006 Aquatic Mesohabitat Mapping Technical Study Plan (PCWA 2006).

²Height of vertical barrier for falls.

³Horizontal leap distance required to clear falls or swimming length of chutes. The horizontal distance of falls was not assessed during the 2005-2006 Aquatic Mapping. In these cases, the fish length applied to the leaping equation was used for the horizontal distance.

⁴Plunge pool depth for falls, depth of water in chutes, or average depth within critical riffles.

⁵Velocity at crest of falls, water velocity in chutes, or average velocity within critical riffles.

⁶Minnows include hardhead, Sacramento pikeminnow, and Sacramento sucker. Distribution was assumed to be limited to the Middle Fork American River downstream of the impassable barrier at river mile 26.6 and the Rubicon River downstream of the impassable barrier at river mile 8.2.

⁷RD = riffle depth; RV = riffle velocity; PD = plunge pool depth; LD = landing depth; LV = landing velocity; FH = falls height; CV = chute velocity and length; CD = chute depth; Turb = turbidity.

Table AQ 6-5. Tributary Confluences that Present Potential Fish Passage Barriers.

Barrier ID	River Mile	Barrier Assessment ¹	Barrier Class	Physical Characteristics at Low Flows					Passable at Low Flows		Barrier Limitation ⁸	Passable at Higher Flows	Comments
				Height ² (ft)	Horizontal Distance or Length (ft) (Measured or Calculated) ³	Depth ⁴ (ft)	Water Velocity ⁵ (ft/s)	Elevation Below High Water (ft) ⁶	Trout	Minnows ⁷			
Middle Fork American River Downstream of Ralston Afterbay													
American Canyon Creek - MF6.4	MF6.4	Qualitative Visit	Falls	-	-	-	-	Above High Water	NO	NO	FH	Potential	Impassable cascade/chute 150' upstream from confluence.
Gas Canyon Creek - MF9.0a	MF9.0	2007 Survey	Falls	2.2	0.2	0.2	0.8	Above High Water	NO	NO	FH PD	NO	Driver's Flat Road Crossing (non-Project general access road)-250' from confluence.
Gas Canyon Creek - MF9.0b	MF9.0	2007 Survey	Falls	1.1	0.8	0.5	1.3	Above High Water	Potential	NO	FH PD LD	Potential	Driver's Flat Road Crossing (non-Project general access road)-250' from confluence.
Gas Canyon Creek - MF9.0c	MF9.0	2007 Survey	Falls	1.4	1.4	0.0	1.9	Above High Water	Potential	NO	FH PD LD	Potential	60' upstream from Driver's Flat Road Crossing.
Todd Creek - MF9.6	MF9.6	2007 Survey	Falls	4.8	1.0	1.2	0.0	Above High Water	NO	NO	FH LD	Potential	Falls at Driver's Flat Road Crossing, no water in tributary at time of survey.
Canyon Creek - MF11.0a	MF11.0	2007 Survey	Falls	6.0	2.4	0.4	1.8	Above High Water	NO	NO	FH PD	NO	80' upstream from confluence with MFAR.
Canyon Creek - MF11.0b	MF11.0	2007 Survey	Chute	-	2.0	0.4	5.4	Above High Water	Potential	Potential	PD	NO	54' upstream from confluence with MFAR.
Canyon Creek - MF11.0c	MF11.0	2007 Survey	Falls	0.9	0.7	0.3	5.2	Above High Water	NO	NO	FH PD	NO	54' upstream from confluence with MFAR.
Canyon Creek - MF11.0d	MF11.0	2007 Survey	Chute	-	2.3	0.4	3.5	Above High Water	Potential	Potential	LD	Potential	54' upstream from confluence with MFAR.
Otter Creek - MF14.1b	MF14.1	2008 Survey	Chute	-	4.5	0.1	6.9	Above High Water	NO	NO	CD PD	Potential	1.5 miles upstream of confluence.
Jesse Canyon Creek - MF17.0a	MF17.0	2007 Survey	Chute	-	5.0	0.1	6.0	Above High Water	NO	NO	LD CD	NO	
Jesse Canyon Creek - MF17.0b	MF17.0	2007 Survey	Falls	4.0	1.0	2.0	-	Above High Water	NO	NO	FH	Potential	
Jesse Canyon Creek - MF17.0c	MF17.0	2007 Survey	Chute	-	10.0	-	-	Above High Water	NO	NO	CV CD	Potential	
Jesse Canyon Creek - MF17.0d	MF17.0	2007 Survey	Chute	-	10.0	-	-	Above High Water	NO	NO	CV CD	Potential	
Jesse Canyon Creek - MF17.0e	MF17.0	2007 Survey	Falls	3.0	1.0	-	-	Above High Water	NO	NO	FH	Potential	
Pond Creek - MF18.1	MF18.1	Qualitative Visit	Falls	-	-	-	-	Above High Water	NO	NO	FH	NO	Cascades, no habitat upstream of confluence.
Dardanelles Creek - MF18.5	MF18.5	Qualitative Visit	Falls	-	-	-	-	Above High Water	NO	NO	FH	NO	Cascades, no habitat upstream of confluence.
Snyder Canyon Creek - MF19.5	MF19.5	Qualitative Visit	Falls	-	-	-	-	Above High Water	NO	NO	FH	NO	Cascades, no habitat upstream of confluence.
Volcano Canyon Creek - MF20.9a	MF20.9	2007 Survey	Falls	1.0	2.4	0.3	0.8	Above High Water	NO	NO	FH PD	Potential	Partially inundated by peaking stage elevation.
Volcano Canyon Creek - MF20.9b	MF20.9	2007 Survey	Falls	0.8	2.4	0.8	1.5	Above High Water	Potential	NO	FH PD	Potential	30.4' upstream of confluence.
Volcano Canyon Creek - MF20.9d	MF20.9	2007 Survey	Falls	2.3	3.9	0.7	0.5	Above High Water	NO	NO	FH PD	Potential	30.4' upstream of confluence.
Volcano Canyon Creek - MF20.9e	MF20.9	2007 Survey	Chute	-	3.5	0.3	3.3	Above High Water	Potential	Potential	PD	Potential	30.4' upstream of confluence.
Volcano Canyon Creek - MF20.9f	MF20.9	2007 Survey	Falls	1.4	1.2	0.7	3.1	Above High Water	Potential	NO	FH PD	Potential	30.4' upstream of confluence.
Middle Fork American River from Ralston Afterbay to Middle Fork Interbay													
Brushy Canyon Creek - MF30.4	MF30.4	Qualitative Visit	Falls	-	-	-	-	Above High Water	NO	NA	FH	NO	Very high gradient channel with large, narrow falls/cascades within the first 1000'.
Middle Fork American River Upstream of Middle Fork Interbay													
Duncan Creek - MF39.7a	MF39.7	2007 Survey	Chute	-	5.5	0.2	3.2	Above High Water	Potential	NA	CD	Potential	Impassable cascade and falls 240' upstream from confluence.
Duncan Creek - MF39.7b	MF39.7	2007 Survey	Falls	6.4	1.0	2.0	-	Above High Water	NO	NA	FH	NO	Falls 240' up from MFAR confluence.
Rubicon River													
Long Canyon Creek - R3.6	LC0.2	2007 Survey	Falls	5.0	1.0	3.0	-	Above High Water	NO	NO	FH	NO	Barrier 0.2 miles upstream from confluence.
Pilot Creek - R5.2b	R5.2	2007 Survey	Falls	1.1	1.8	1.3	3.1	Above High Water	Potential	NO	FH	Potential	Barrier 84' upstream from Rubicon confluence.
Pilot Creek - R5.2c	R5.2	2007 Survey	Falls	1.7	1.0	0.2	3.5	Above High Water	NO	NO	FH PD	Potential	No standing wave and resting pool provides no location to jump upper falls.
Pilot Creek - R5.2d	R5.2	2007 Survey	Falls	3.9	5.9	2.2	8.0	Above High Water	NO	NO	FH LV	NO	Barrier 222' upstream from Rubicon confluence.
Pilot Creek - R5.2e	R5.2	2008 Survey	Chute	-	6.3	0.3	7.0	Above High Water	Potential	Potential	LD	NO	Barrier 222' upstream from Rubicon confluence.
Pilot Creek - R5.2f	R5.2	2007 Survey	Falls	2.5	4.1	2.1	5.0	Above High Water	NO	NO	FH Turb	NO	Barrier 222' upstream from Rubicon confluence.
South Fork Rubicon River - R22.6	R22.6	Aerial Survey	Falls	-	-	-	-	Above High Water	NO	NA	FH	NO	Surveyed from helicopter. Impassable barriers immediately upstream of confluence.

Table AQ 6-5. Tributary Confluences that Present Potential Fish Passage Barriers (continued).

Barrier ID	River Mile	Barrier Assessment ¹	Barrier Class	Physical Characteristics at Low Flows					Passable at Low Flows		Barrier Limitation ⁸	Passable at Higher Flows	Comments
				Height ² (ft)	Horizontal Distance or Length (ft) (Measured or Calculated) ³	Depth ⁴ (ft)	Water Velocity ⁵ (ft/s)	Elevation Below High Water (ft) ⁶	Trout	Minnows ⁷			
Long Canyon Creek													
Wallace Canyon	LC5.6	Qualitative Visit	Falls	-	-	-	-	-	NO	NA	FH FD	NO	Falls and cascades upstream of confluence, no habitat available.
North Fork Long Canyon Creek													
No Tributary Barriers		2007 Survey											
South Fork Long Canyon Creek													
No Tributary Barriers		2007 Survey											
Duncan Creek													
No Tributary Barriers		2007 Survey											

¹Barriers visited during 2007 barrier surveys were assessed following the methods of Powers and Orsborn (1985) and Thompson (1972). Barriers visited in 2006 were assessed following the 2006 Aquatic Mesohabitat Mapping Technical Study Plan (PCWA 2006).

²Height of vertical barrier for falls.

³Horizontal leap distance required to clear falls or swimming length of chutes. The horizontal distance of falls was not assessed during the 2006 Aquatic Mapping. In these cases, the fish length applied to the leaping equation was used for the horizontal distance.

⁴Plunge pool depth for falls, depth of water in chutes, or average depth within critical riffles.

⁵Velocity at crest of falls, water velocity in chutes, or average velocity within critical riffles.

⁶Elevation is referenced to the high water mark of the mainstem for tributary streams and the full pool elevation for reservoir inlets.

⁷Minnows⁷ include hardhead, Sacramento pikeminnow, and Sacramento sucker. Distribution was assumed to be limited to the Middle Fork American River downstream of the impassable barrier at river mile 26.6 and the Rubicon River downstream of the impassable barrier at river mile 8.2.

⁸RD = riffle depth; RV = riffle velocity; PD = plunge pool depth; LD = landing depth; LV = landing velocity; FH = falls height; CV = chute velocity and length; CD = chute depth; Turb = turbidity.

Table AQ 6-6. Reservoir Pool Inlets that Present Potential Fish Passage Barriers.

Barrier ID	River Mile	Barrier Assessment ¹	Barrier Class	Physical Characteristics at Low Flows					Passable at Low Flows		Barrier Limitation ⁸	Passable at Higher Flow	Comments
				Height ² (ft)	Horizontal Distance or Length (ft) (Measured or Calculated) ³	Depth ⁴ (ft)	Water Velocity ⁵ (ft/s)	Elevation Below High Water (ft) ⁶	Trout	Minnows ⁷			
Middle Fork American River Downstream of Ralston Afterbay													
No Reservoir Inlet Barriers		2007 Survey											
Middle Fork American River from Ralston Afterbay to Middle Fork Interbay													
No Reservoir Inlet Barriers		2007 Survey											
Middle Fork American River Upstream of Middle Fork Interbay													
No Reservoir Inlet Barriers		2007 Survey											
Middle Fork American River Upstream of French Meadows Reservoir													
No Reservoir Inlet Barriers		2007 Survey											
Rubicon River Upstream of Ralston Afterbay													
No Reservoir Inlet Barriers		2007 Survey											
Rubicon River Upstream of Hell Hole Reservoir													
Hell Hole Reservoir Inlet - R34.5c	R34.5	2007 Survey	Falls	3.0	4.2	2.4	4.9	47.0	NO	NA	FH	No	
Hell Hole Reservoir Inlet - R35.2a	R35.2	2007 Survey	Chute	-	17.5	0.6	7.6	45.0	NO	NA	CV	Potential	
Hell Hole Reservoir Inlet - R35.2b	R35.2	2007 Survey	Chute	-	17.5	1.3	7.0	45.0	NO	NA	CV	Potential	
Hell Hole Reservoir Inlet - R35.8a	R35.8	2007 Survey	Falls	35.0	-	8.0	-	19.0	NO	NA	FH	No	
Hell Hole Reservoir Inlet - R35.8b	R35.8	2007 Survey	Falls	15.0	-	-	-	4.0	NO	NA	FH	No	
Five Lakes Creek - 5L0.2a	5L0.2	2007 Survey	Chute	-	5.5	0.2	4.2	13.0	Potential	NA	CD	Potential	
North Fork Long Canyon Creek													
No Reservoir Inlet Barriers		2007 Survey											
South Fork Long Canyon Creek													
South Fork Long Canyon Diversion Pool Inlet	SFLC3.3	2007 Survey	Critical Riffle	-	-	0.2	1.0	5.1	Potential	NA	RD	Potential	Critical riffle absorbed by diversion pool high water level.
Duncan Creek													
No Reservoir Inlet Barriers		2007 Survey											

¹Barriers visited during 2007 barrier surveys were assessed following the methods of Powers and Orsborn (1985) and Thompson (1972). Barriers visited in 2006 were assessed following the 2006 Aquatic Mesohabitat Mapping Technical Study Plan (PCWA 2006).

²Height of vertical barrier for falls.

³Horizontal leap distance required to clear falls or swimming length of chutes. The horizontal distance of falls was not assessed during the 2006 Aquatic Mapping. In these cases, the fish length applied to the leaping equation was used for the horizontal distance.

⁴Plunge pool depth for falls, depth of water in chutes, or average depth within critical riffles.

⁵Velocity at crest of falls, water velocity in chutes, or average velocity within critical riffles.

⁶Elevation is referenced to the high water mark of the mainstem for tributary streams and the full pool elevation for reservoir inlets.

⁷"Minnows" include hardhead, Sacramento pikeminnow, and Sacramento sucker. Distribution was assumed to be limited to the Middle Fork American River downstream of the impassable barrier at river mile 26.6 and the Rubicon River downstream of the impassable barrier at river mile 8.2.

⁸RD = riffle depth; RV = riffle velocity; PD = plunge pool depth; LD = landing depth; LV = landing velocity; FH = falls height; CV = chute velocity and length; CD = chute depth; Turb = turbidity.

FIGURES

Figure AQ 6-1. Fish Passage Objectives, Related Study Elements, and Reports.

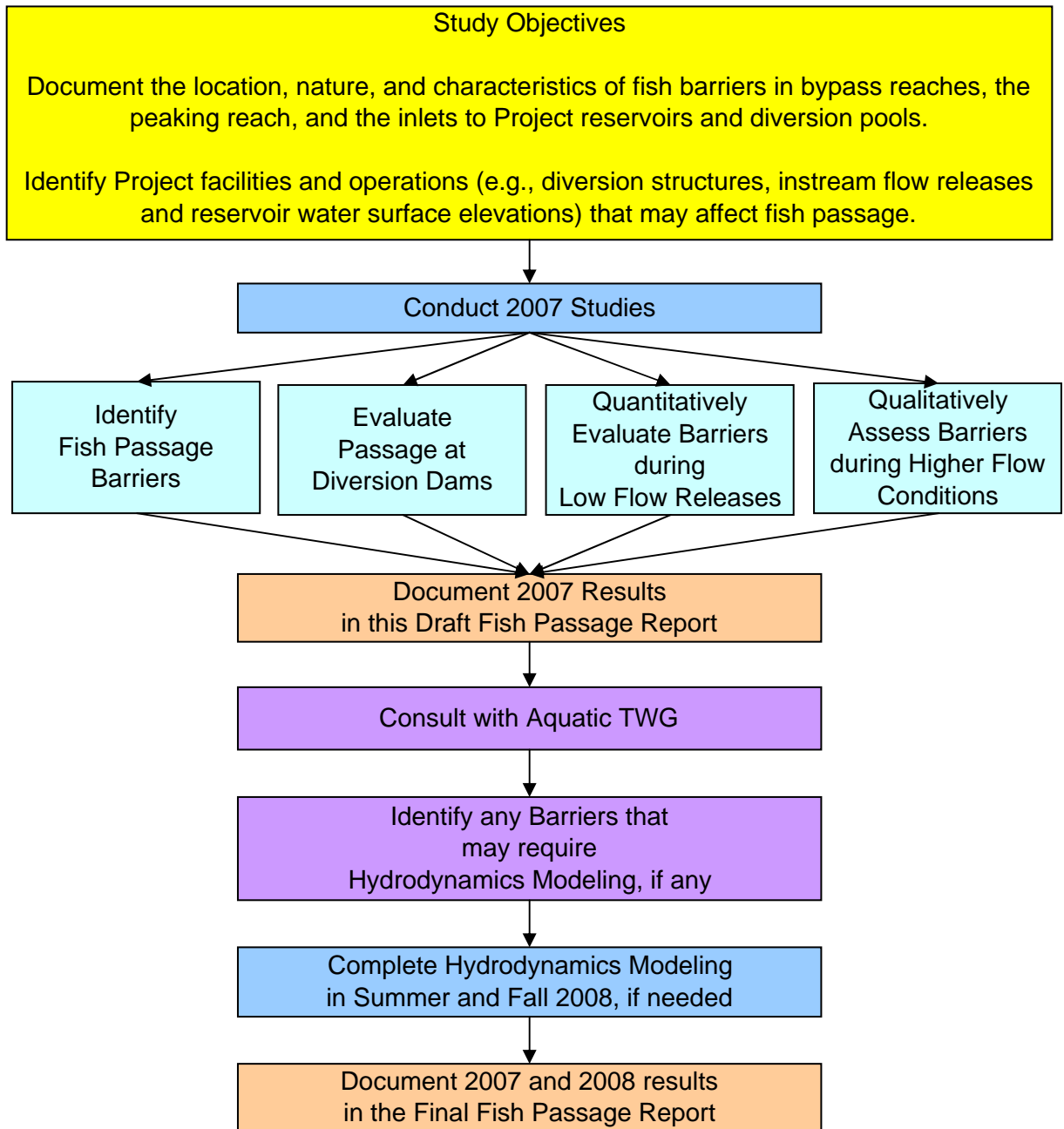
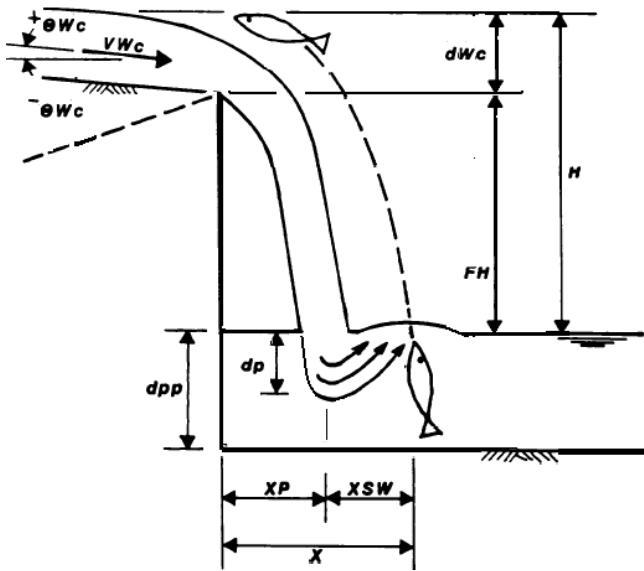
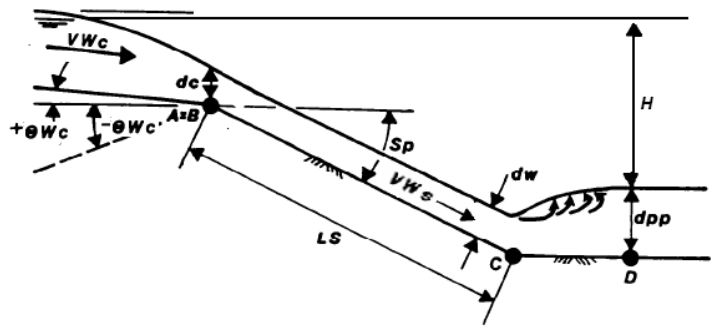

Figure AQ 6-2. Summary of Parameters Measured at Each Potential Barrier during 2007 Field Visits.

Fish Passage Parameters Measured (Abbreviations Shown on Schematics ¹ Below)			
Falls	Chutes	Cascades	Critical Riffles
Width of channel/water at top of crest	Width of water at crest and in chute	Also measure the following for each chute/ fall	Width of riffle
Water depth at crest (dWc)	Water depth at crest (dWc)	Resting pool width, length, and depth if resting pools are present.	Depth across riffle
Water velocity at crest (VWc)	Water velocity at crest (VWc)	Air entrainment %	Velocity across riffle
Angle of water at crest ($\pm \theta Wc$)	Angle of water at crest ($\pm \theta Wc$)	Turbulence (passable or not)	
Fall height (FH)	Chute height (H)		
Depth of plunge pool (dpp)	Depth of water in chute (dW)		
Depth of plunging water (dp)	Velocity of water in chute (VWs)		
Distance from crest to plunge (Xp)	Length of chute slope (LS)		
Distance from plunge to standing wave (XSW)	Slope of chute passage area (Sp)		
	Depth of plunge pool (dpp)		



Fall Measurements



Chute Measurements

¹Powers, P. D. and J. F. Orsborn. 1985. Analysis of Barriers to Upstream Migration: An Investigation of the Physical and Biological Conditions Affecting Fish Passage Success at Culverts and Waterfalls. BPA Report No. DOE/BP-36523-1.

Figure AQ 6-3. Trout and Minnow Swimming Speed Versus Time (12-inch fish).¹

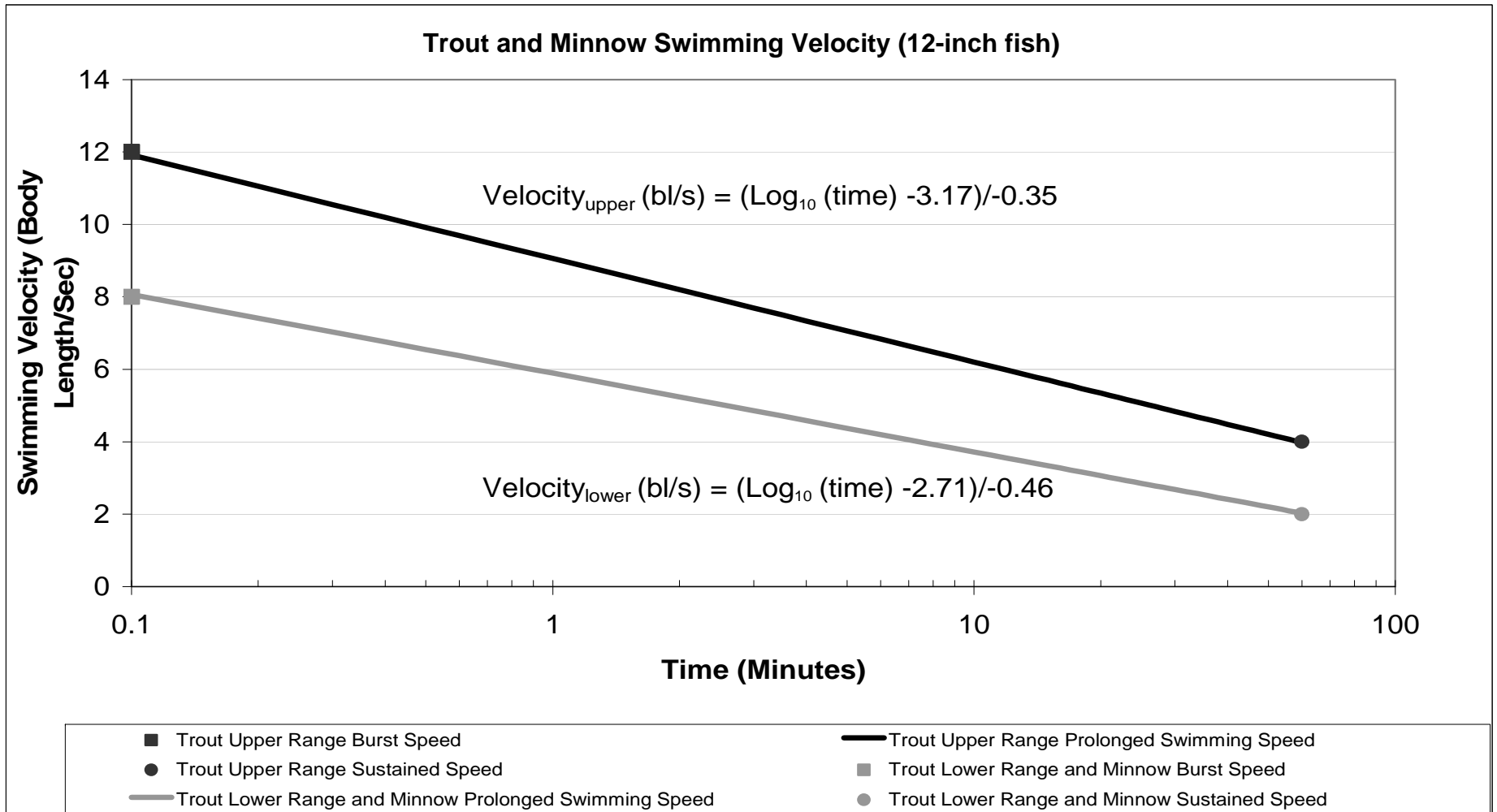

¹See Appendix B for calculation details.

Figure AQ 6-4. Trout and Minnow Vertical and Horizontal Leaping Ability (12-inch fish).¹

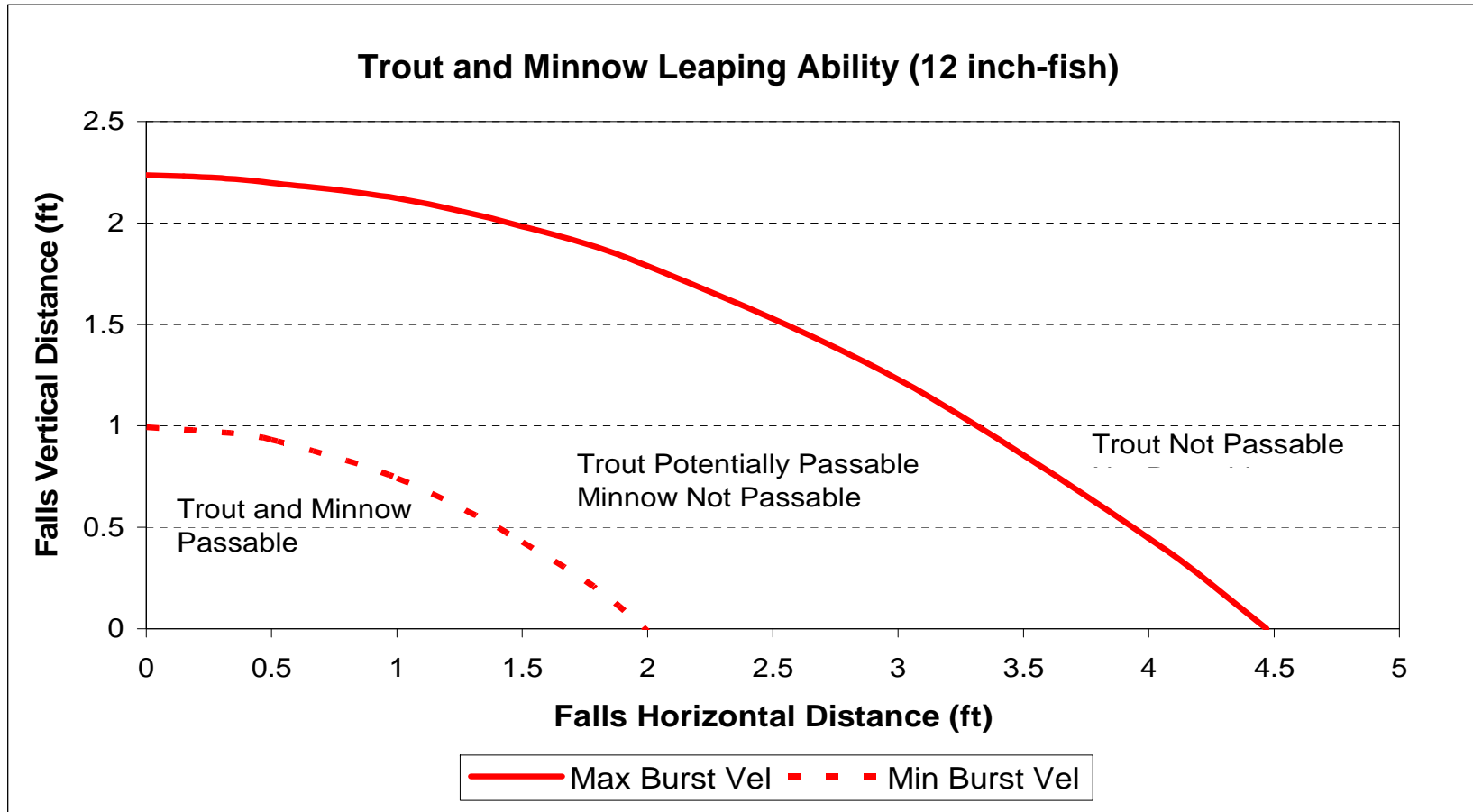

¹See Appendix B for calculation details.

Figure AQ 6-5. Chute Water Velocity Versus Swimming Distance (12-inch fish).¹

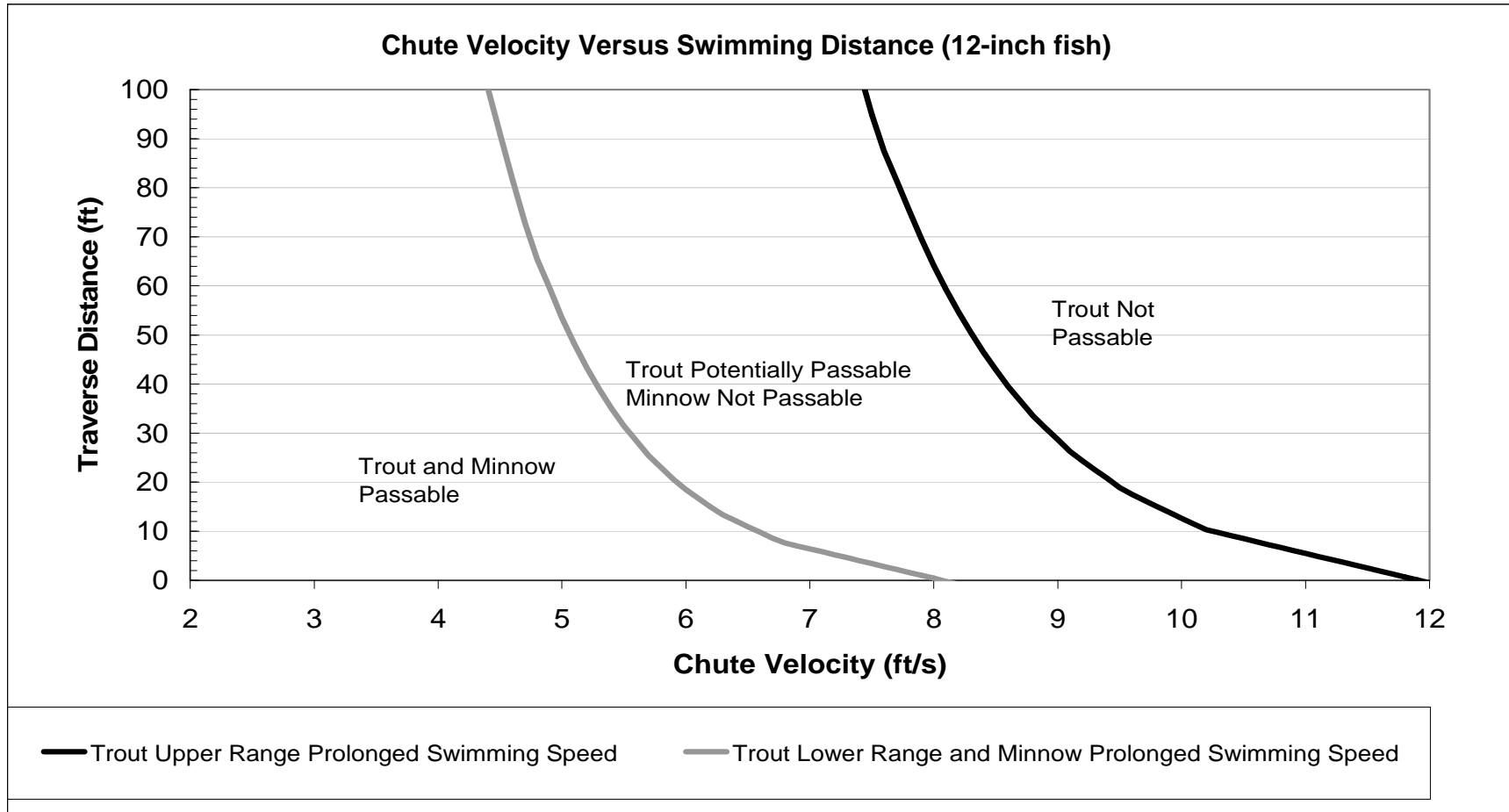

¹See Appendix B for calculation details.

MAPS

APPENDIX A
Quantitative Barrier Assessment Data Sheet

Fish Passage Data Sheet PCWA

River Reach Surveyed:

Date:

Crew:

Downstream GPS Coordinates:

Upstream GPS Coordinates:

Total Number of Barriers Observed:

General Overview River Photo Numbers:

Detailed Barrier Photo Numbers (list all):

Draw sketch of the river reach or tributary junction surveyed with approximate the location of barriers and photo points labeled. Note: number barriers and photos to correspond to numbers on detailed barrier sheets.

Draw Sketch Here

Comments:

River Discharge: _____ cfs

Width (units =)																				
Depth/Elevation (units =)																				
Velocity (units =)																				

Barrier location (e.g., GPS Coordinates): _____ Detailed Barrier Photo Numbers: _____

Class (circle): Falls Chute Cascade (combination falls/chutes, boulder, turbulent) Critical Riffle

Discharge: _____ cfs

Critical Riffle Measurements and/or Discharge Measurement (circle one)

Width (units =)																				
Depth/Elevation (units =)																				
Velocity (units =)																				

Detailed Barrier Sketch (see images below...use compound falls/chutes or chutes/falls as appropriate). Number each barrier in the order of the measurements recorded below the sketch:

Record the measurements below (with units). Order the measurements as in the sketch if there are multiple chutes/falls.

Fall Measurements

- Width of channel/water at top of crest:
- Water depth at crest (d_{wc}):
- Water velocity at crest (V_{wc}):
- Angle of water at crest ($\pm \theta_{wc}$):
- Fall height (FH):
- Depth of plunge pool (dpp):
- Depth of plunging water (dp):
- Dist. from crest to plunge (X_p):
- Dist. from plunge to standing wave (XSW):

Chute Measurements

- Width of water at crest and in chute:
- Water depth at crest (d_{wc}):
- Water velocity at crest (V_{wc}):
- Angle of water at crest ($\pm \theta_{wc}$):
- Chute height (H):
- Depth of water in chute (d_w):
- Velocity of water in chute (V_{ws}):
- Length of chute slope (LS):
- Slope of chute passage area (Sp):
- Depth of plunge pool (dpp):

Cascade Measurements (Measure each chute/fall)

- Also measure the following
- Resting pool width:
- Resting pool length:
- Resting pool depth:
- Air entrainment %:
- Turbulence (passable or not):

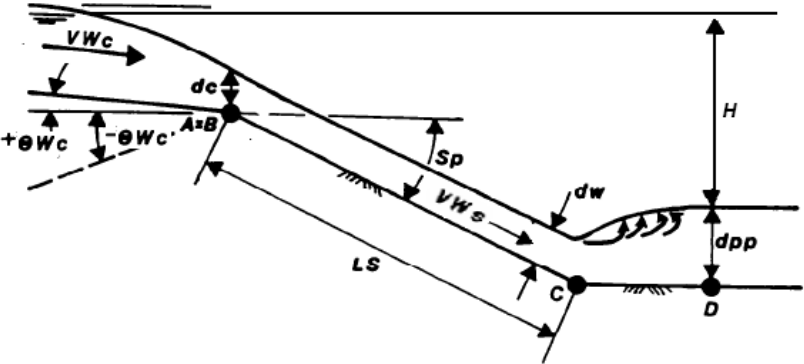
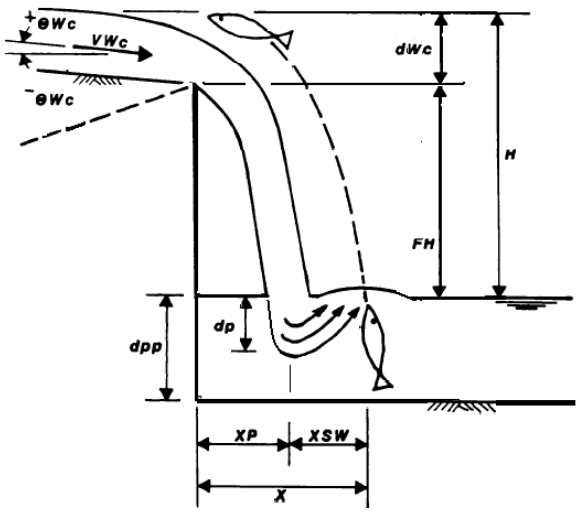

APPENDIX B
Quantitative Fish Barrier Evaluation Approach

1.0 INTRODUCTION

Upstream passage was evaluated quantitatively using the swimming and leaping capabilities of trout (particularly rainbow trout) and minnows/suckers (hardhead, Sacramento pikeminnow, Sacramento sucker). The upstream fish passage assessment methodology outlined in Powers and Orsborn (1985) and Thompson (1972) was used to evaluate passage at potential vertical barriers, high velocity chutes, and/or critical riffles based on field measurement of the barriers in the field during base flows. Barriers were analyzed for 12-inch (340 mm) trout and minnows/suckers.

2.0 FISH SWIMMING AND LEAPING CAPABILITIES

A range of swimming velocity was used for the trout (high and low swimming estimates). Minnow and sucker swimming capability was set at the lower end of the trout swimming range. Burst swimming velocity was used to determine the leaping ability of fish (i.e., their ability to navigate vertical barriers). Prolonged and sustained swimming capability was used to determine the ability of fish to navigate high velocity water in chutes and riffles (Powers and Orsborn 1985).

Burst swimming (less than 0.1 minutes) was assumed to range between 8 and 12 body lengths/sec for salmonids (trout) (Beamish 1978; Reiser and Peacock 1985; Videler 1993). Burst swimming for cyprinids (minnows) and catostomids (suckers) was set on the lower end of the trout range (8 body lengths/sec). The sixty-minute sustained swimming velocity was assumed to be between 2 and 4 body lengths/sec for trout (Brett and Glass 1973; Beamish 1978; Reiser and Peacock 1985) and approximately 2 body lengths/sec for minnows/suckers¹ (Myrick and Cech 2000; Berry and Pimentael 1985). Prolonged swimming (0.1–60 minutes) was assumed to vary between burst and sustained swimming speed logarithmically (Viedeler 1993). Figure AQ 6-3 shows the assumed swimming capabilities of fish.

The size of fish used for the analysis was set at an intermediate size of 12 inches (340 mm). In the small streams (Duncan Creek, Long Canyon creeks) the maximum trout size was smaller than 12 inches, about 9 inches (230 mm FL). In the intermediate and larger sized rivers (Middle Fork American River above Ralston Afterbay, Rubicon River, Middle Fork American River below Ralston Afterbay) the maximum trout size was larger than 12 inches, about 15 inches (380 mm FL) or greater (PCWA 2008). For fish in the approximately 12-inch and less size, empirical fish leaping data for brook trout indicate that smaller fish (e.g., 6 inches) can leap as high as larger fish (e.g., 8+ inches) (Kondratieff and Myrick 2006). This is partly due to the fact that the maximum swimming speed per body length is higher for smaller fish (e.g., <12 inches) than it is for

¹ Critical swimming velocity data (a laboratory measure of prolonged swimming capacity) for hardhead, Sacramento pikeminnow, Colorado pikeminnow, and Sacramento sucker (Myrick and Cech 2000; Berry and Pimentel 1985) were compared to data for rainbow trout (Beamish 1978; Hawkins and Quinn 1996; Jain et al. 1997). Minnow/sucker species swimming velocities were comparable to the lower range observed for trout (typically about 2 body lengths/sec).

larger fish (e.g., >12+ inches) (see compilation of data in Kondratieff and Myrick 2006). As a result, we used the leaping and swimming ability of a 12-inch fish as reasonable representation for the passage capabilities of various sized fish in the Project area. The same fish size was used for hardhead, Sacramento pikeminnow, and Sacramento sucker.

A water temperature of 15 °C was used to help estimate the approximate 60 minute sustained swimming speed discussed above (Brett and Glass 1973). In general, the effects of water temperature on swimming ability in the range of about 10–20°C are relatively modest (e.g., Myrick and Cech 2000) and water temperature was not used to modify swimming velocity in this analysis.

3.0 LEAPING BARRIERS (FALLS)

Passage of vertical barriers (falls) requires fish to leap the vertical and horizontal dimensions of the falls. Passage also requires suitable takeoff conditions at the plunge pool and suitable landing conditions at the falls crest.

Vertical and Horizontal Leaping. In order for a fish to clear a leaping barrier they must be able to leap high enough (H) to reach the crest of the barrier and far enough (X) to cover the distance from the standing wave in the plunge pool (the point of optimal leap) to the crest of the barrier. Leaping ability was based on trajectory equations that convert the burst swimming speed of a fish into X and H components (Powers and Orsborn 1985):

$$H = (\tan A) X - g (X)^2 / 2(VF \cos A)^2$$

Where VF is the burst speed of the fish (ft/s), A is the leaping angle, and g is a constant acceleration due to gravity (32.2 ft/sec²). Figure AQ 6-4 shows the vertical and horizontal leaping capability of a 12-inch fish (Note: all potential leaping angles were tested to determine the maximum X distance and H that could be navigated).

Leaping barriers were considered impassable for trout if the barrier could not be cleared at a burst speed of 12 body lengths/sec. Leaping barriers were considered potentially passable for trout if they could be cleared at a burst speed between 8 and 12 body lengths/sec and barriers were considered to be passable if they could be cleared at burst speed of 8 body lengths/sec or less. Leaping barriers were considered impassable for minnows/suckers (e.g., hardhead) if they could not be cleared at a burst velocity greater than 8 body lengths/sec and passable if they could be cleared at a burst velocity of 8 body lengths/sec or less. Table AQ 6-1B shows a summary of leaping barrier passability based on fish burst speed.

AQ 6 Appendix B Table 6-1. Leaping Barrier Passability Based on Fish Burst Speed.

Falls Barrier Rating (Based on Figure AQ 6-4 and Burst Speeds Listed in This Table)	Burst Speed (body lengths /sec) Required to Leap Barrier	
	Trout	Minnows / Suckers
Passable	≤8	≤8
Potentially Passable	>8–12	NA
Impassable	>12	>8

Falls Plunge Pool Conditions. If the plunge pool depth was greater than the full body length of a fish, the leaping ability of a fish was assumed to be unhampered. If, however, the plunge pool depth was between 1 and ½ body lengths and/or the penetration of the plunging water reached the bottom of the pool, the leaping ability was assumed to be reduced and the barrier (all else being passable) was deemed only potentially passable. If the plunge pool depth was less than 1/2 body length, the barrier was deemed impassable. Table AQ 6-2B shows a summary of falls barrier passability based on plunge pool conditions.

Falls Crest Landing Conditions. If the water velocity at the crest of the falls was greater than the fish's burst velocity (Figure AQ 6-3), the barrier was classified as impassable. If the crest landing area was deeper than the fish's body depth, the crest was analyzed as a chute / critical riffle (see below). If the depth of the crest was between 1 and ½ times the depth of the fish and passable as analyzed above, it was considered only potentially passable due to the shallow depth, unless the crest sloped downward in the upstream direction in which case the falls was considered passable. If the crest depth was less than ½ body depth, the falls was considered impassable. The body depth of fish was assumed to be 0.22 times the length of the fish (USFWS 2008). Table AQ 6-2B shows a summary of falls barrier passability based on crest landing conditions.

AQ 6 Appendix B Table 6-2. Falls Barrier Passability Based on Plunge Pool Conditions and Falls Crest Landing Conditions.

Falls Barrier Rating (Based on Plunge Pool Depth and Crest Landing Conditions)	Plunge Pool Depth	Falls Crest Landing Conditions ¹
Passable	≥ full body length of a fish	Depth of the crest was ≥1 times the depth of the fish or the crest ½–<1 times the depth of the fish and sloped downward in the upstream direction and velocity was < than the fish's burst velocity.
Potentially Passable	½–1 body length or penetration of the plunging water reached the bottom of the pool	Depth of the crest was between 1–½ times the depth of the fish and velocity was < than the fish's burst velocity.
Impassable	<½ body length	Depth of the crest <½ times depth of the fish or water velocity at the crest was > than the fish's burst velocity

¹Depth of the fish was 0.22 times fish length.

4.0 CHUTES AND CRITICAL RIFFLES (SWIMMING BARRIERS)

Fish passage assessment of chute and critical riffle barriers required the water velocity to be less than the upstream distance swimming capabilities of the fish and the depth to be great enough to pass fish.

Water Velocity and Chute Length- If the water velocity of the chute or critical riffle was greater than the fish's burst velocity (12 body lengths/sec for trout or 8 body lengths/sec for minnows/suckers), it was considered an impassable barrier. If the water velocity was less than the fish's sustained velocity, 2 body lengths/sec (for both trout and minnows/suckers) the barrier was classified as passable. Otherwise, if the velocity was between the burst and sustained velocity, the prolonged swimming speed equation (Figure AQ 6-3) was used to determine if the fish could pass the length of the barrier. For minnows/suckers, the lower velocity swimming equation was used. For trout, both the high and low velocity equations were used. If the barrier could be navigated with the lower velocity equation, it was considered passable. If the barrier could only be navigated using the higher velocity equation, the barrier was considered potentially

passable. Table AQ6-3B shows a summary of chute and critical riffle barrier passability based on water velocity and depth and chute length.

Depth -- If the water velocity of a chute or riffle was determined to be passable, but the water depth was between 1 and ½ times the fish's body depth, swimming ability was assumed to be impaired and the barrier was classified as potentially passable. If the water depth was less than ½ times the fish's body depth, the barrier was classified as impassable.

AQ 6 Appendix B Table 6-3. Summary of Chute and Critical Riffle Barrier Passability Based on Water Velocity, Water Depth, and Chute Length.

Chute Barrier Rating (Based on Listed Water Velocity, Length, and Depth Conditions)	Water Velocity and Length	Water Depth
Passable	Water velocity < fish's sustained velocity (2 body lengths/sec) or fish's prolonged velocity / swimming distance relationship exceeded velocity / length of chute (Figure AQ 6-5)	Depth ≥1 times the depth of the fish
Potentially Passable	NA	Depth was ½–1 times the fish's body length
Impassable	Water velocity > fish's burst velocity (8 body lengths/sec for minnows/suckers or 12 body lengths/sec for trout) or fish's prolonged velocity / swimming distance relationship was < than the velocity / length of chute (Figure AQ 6-5)	Depth was <½ times fish's body depth

APPENDIX C
Detailed Fish Passage Barrier Descriptions

	Page
Barriers to Fish Passage – Infrastructure.....	1-4
Barriers to Fish Passage – Tributary Confluences and Reservoir Pool Inlets.....	5-16
Barriers to Fish Passage – Natural Instream Barriers.....	17-28
Barriers to Fish Passage – Barriers Assessed from Low Altitude Helicopter Survey.....	29-38

Barriers to Fish Passage – Infrastructure

Barrier Characteristics

Barrier Identification	River Mile ¹	Location (UTM) ²		Barrier Class	Passable		Photograph
		Easting	Northing		Trout	Minnows ³	
Middle Fork American River Downstream of Ralston Afterbay							
Ralston Afterbay Dam	MF24.7	695141	4319549	Falls	NO	NO	1
Middle Fork American River from Ralston Afterbay to Middle Fork Interbay							
Abandoned Weir below Middle Fork Interbay	MF35.5	707414	4322449	Falls	NO	NA	2
Middle Fork Interbay Dam	MF35.6	707538	4322404	Falls	NO	NA	3
Middle Fork American River Upstream of Middle Fork Interbay							
Middle Fork American River Gage and Weir below French Meadows Dam	MF46.6	717789	4331977	Falls	Potential	NA	4

¹Abbreviation: MF = Middle Fork American River

²Universal Transverse Mercator Zone 10 North, North American Datum 1983

³Minnows include hardhead, Sacramento pikeminnow, and Sacramento sucker. Distribution was assumed to be limited to the Middle Fork American River downstream of Middle Fork Interbay and the Rubicon River downstream of the impassable barrier at river mile 15.3

Barrier Photographs

1



2



3



4



Barriers to Fish Passage – Infrastructure (continued)

Barrier Characteristics

Barrier Identification	River Mile ¹	Location (UTM) ²		Barrier Class	Passable		Photograph
		Easting	Northing		Trout	Minnows ³	
Middle Fork American River Upstream of Middle Fork Interbay (continued)							
French Meadows Dam	MF47.2	718733	4332190	Falls	NO	NA	5
Rubicon River							
Hell Hole Dam	R30.5	724173	4326543	Falls	NO	NA	6
North Fork Long Canyon Creek							
River Crossing of Hell Hole-Middle Fork Tunnel	NFLC0.6	715166	4322914	Falls	NO	NA	7
Cascade below weir below Diversion Dam - NFLC3.1	NFLC3.1	717921	4325435	Falls	NO	NA	8

¹Abbreviation: MF = Middle Fork American River; R = Rubicon River; NFLC = North Fork Long Canyon Creek

²Universal Transverse Mercator Zone 10 North, North American Datum 1983

³Minnows include hardhead, Sacramento pikeminnow, and Sacramento sucker. Distribution was assumed to be limited to the Middle Fork American River downstream of Middle Fork Interbay and the Rubicon River downstream of the impassable barrier at river mile 15.3

Barrier Photographs

5



6



7



8



Barriers to Fish Passage – Infrastructure (continued)

Barrier Characteristics

Barrier Identification	River Mile ¹	Location (UTM) ²		Barrier Class	Passable		Photograph
		Easting	Northing		Trout	Minnows ³	
North Fork Long Canyon Creek (continued)							
North Fork Long Canyon Diversion Dam Weir	NFLC3.1	717921	4325435	Falls	NO	NA	9
North Fork Long Canyon Diversion Dam	NFLC3.1	717932	4325458	Falls	NO	NA	9
South Fork Long Canyon Creek							
South Fork Long Canyon Diversion Dam	SFLC3.3	718874	4325511	Falls	NO	NA	10
14N28 Road Crossing to Middle Meadows Group Campground	SFLC3.5	719193	4325747	Chute	NO	NA	11

¹Abbreviation: NFLC = North Fork Long Canyon Creek, SFLC = South Fork Long Canyon Creek

²Universal Transverse Mercator Zone 10 North, North American Datum 1983

³Minnows include hardhead, Sacramento pikeminnow, and Sacramento sucker. Distribution was assumed to be limited to the Middle Fork American River downstream of Middle Fork Interbay and the Rubicon River downstream of the impassable barrier at river mile 15.3

Barrier Photographs

9



10



11



Barriers to Fish Passage – Infrastructure (continued)

Barrier Characteristics

Barrier Identification	River Mile ¹	Location (UTM) ²		Barrier Class	Passable		Photograph
		Easting	Northing		Trout	Minnows ³	
Duncan Creek							
Duncan Diversion Dam	D8.6	717696	4334707	Falls	NO	NA	13
Duncan Creek Gage and Weir above Diversion Dam	D8.8	717873	4334888	Falls	Potential	NA	14

¹Abbreviation: D=Duncan Creek

²Universal Transverse Mercator Zone 10 North, North American Datum 1983

³Minnows include hardhead, Sacramento pikeminnow, and Sacramento sucker. Distribution was assumed to be limited to the Middle Fork American River downstream of Middle Fork Interbay and the Rubicon River downstream of the impassable barrier at river mile 15.3

Barrier Photographs

13



14



Barriers to Fish Passage – Tributary Confluences and Reservoir Pool Inlets

Barrier Characteristics

Barrier Identification	River Mile ¹	Location (UTM) ²		Barrier Class	Passable		Photograph
		Easting	Northing		Trout	Minnows ³	
Middle Fork American River Downstream of Ralston Afterbay							
American Canyon Creek - MF6.4	MF6.4	678262	4311638	Falls	NO	NO	1-2

¹Abbreviation: MF = Middle Fork American River

²Universal Transverse Mercator Zone 10 North, North American Datum 1983

³Minnows include hardhead, Sacramento pikeminnow, and Sacramento sucker. Distribution was assumed to be limited to the Middle Fork American River downstream of Middle Fork Interbay and the Rubicon River downstream of the impassable barrier at river mile 15.3

Barrier Photographs

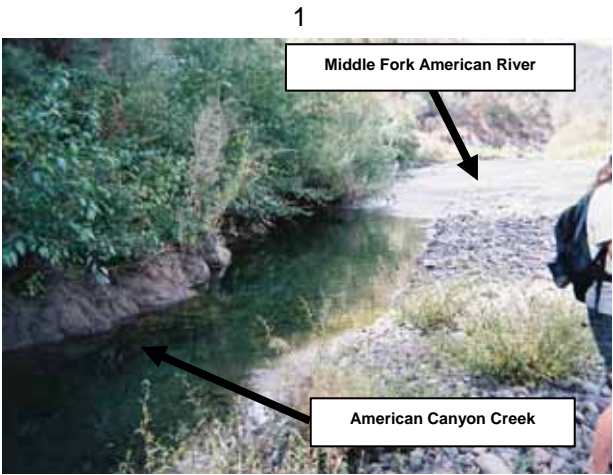

Barriers to Fish Passage – Tributary Confluences and Reservoir Pool Inlets (continued)

Barrier Characteristics

Barrier Identification	River Mile ¹	Location (UTM) ²		Barrier Class	Passable		Photograph
		Easting	Northing		Trout	Minnows ³	
Middle Fork American River Downstream of Ralston Afterbay (continued)							
Gas Canyon Creek - MF9.0a ⁴	MF9.0	679108	4314829	Falls	NO	NO	3
Gas Canyon Creek - MF9.0b ⁴	MF9.0	679108	4314829	Falls	Potential	NO	3
Gas Canyon Creek - MF9.0c	MF9.0	679108	4314829	Falls	Potential	NO	4
Todd Creek - MF9.6	MF9.6	679855	4314604	Falls	NO	NO	5
Canyon Creek - MF11.0e	MF11.0	681803	4313651	Critical Riffle	YES	YES	6

¹Abbreviation: MF = Middle Fork American River

²Universal Transverse Mercator Zone 10 North, North American Datum 1983

³Minnows include hardhead, Sacramento pikeminnow, and Sacramento sucker. Distribution was assumed to be limited to the Middle Fork American River downstream of Middle Fork Interbay and the Rubicon River downstream of the impassable barrier at river mile 15.3

⁴Barrier created by a non-Project general access road

Barrier Photographs

3



4



5

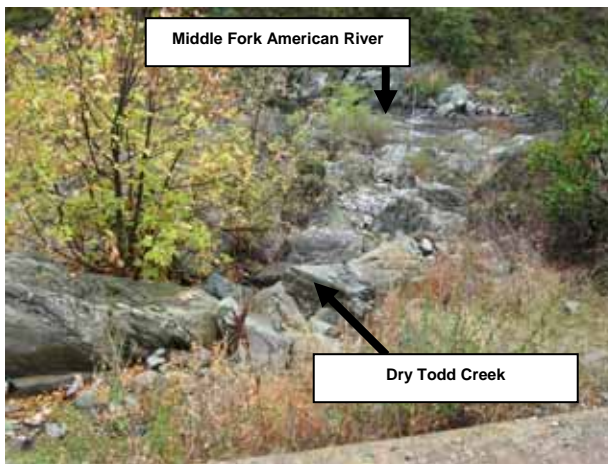

6



Barriers to Fish Passage – Tributary Confluences and Reservoir Pool Inlets (continued)

Barrier Characteristics

Barrier Identification	River Mile ¹	Location (UTM) ²		Barrier Class	Passable		Photograph
		Easting	Northing		Trout	Minnows ³	
Middle Fork American River Downstream of Ralston Afterbay (continued)							
Canyon Creek - MF11.0a	MF11.0	681803	4313651	Falls	NO	NO	7
Canyon Creek - MF11.0b	MF11.0	681803	4313651	Chute	Potential	Potential	7
Canyon Creek - MF11.0c	MF11.0	681803	4313651	Falls	NO	NO	7
Canyon Creek - MF11.0d	MF11.0	681803	4313651	Chute	NO	NO	7
Otter Creek - MF14.1	MF14.1	685731	4314192	Critical Riffle	YES ⁴	YES ⁴	8
Otter Creek 1.5 miles upstream from confluence	OC1.5	685731	4314192	Chute	NO	NO	No Photograph
Jesse Canyon Creek - MF17.0a	MF17.0	687760	4316253	Chute	NO	NO	9
Jesse Canyon Creek - MF17.0b	MF17.0	687760	4316253	Falls	NO	NO	10

¹Abbreviation: MF = Middle Fork American River, OC = Otter Creek

²Universal Transverse Mercator Zone 10 North, North American Datum 1983

³Minnows include hardhead, Sacramento pikeminnow, and Sacramento sucker. Distribution was assumed to be limited to the Middle Fork American River downstream of Middle Fork Interbay and the Rubicon River downstream of the impassable barrier at river mile 15.3

⁴During surveys the critical riffle was passable, however during low flow periods the riffle may become impassable

Barrier Photographs

7



8



9



10



Barriers to Fish Passage – Tributary Confluences and Reservoir Pool Inlets (continued)

Barrier Characteristics

Barrier Identification	River Mile ¹	Location (UTM) ²		Barrier Class	Passable		Photograph
		Easting	Northing		Trout	Minnows ³	
Middle Fork American River Downstream of Ralston Afterbay (continued)							
Jesse Canyon Creek - MF17.0c	MF17.0	687760	4316253	Chute	NO	NO	11
Jesse Canyon Creek - MF17.0d	MF17.0	687760	4316253	Chute	NO	NO	12
Jesse Canyon Creek - MF17.0e	MF17.0	687760	4316253	Falls	NO	NO	13
Pond Creek - MF18.1	MF18.1	688082	4317906	Falls	NO	NO	14

¹Abbreviation: MF = Middle Fork American River

²Universal Transverse Mercator Zone 10 North, North American Datum 1983

³Minnows include hardhead, Sacramento pikeminnow, and Sacramento sucker. Distribution was assumed to be limited to the Middle Fork American River downstream of Middle Fork Interbay and the Rubicon River downstream of the impassable barrier at river mile 15.3

Barrier Photographs

11



12



13



14



Barriers to Fish Passage – Tributary Confluences and Reservoir Pool Inlets (continued)

Barrier Characteristics

Barrier Identification	River Mile ¹	Location (UTM) ²		Barrier Class	Passable		Photograph
		Easting	Northing		Trout	Minnows ³	
Middle Fork American River Downstream of Ralston Afterbay (continued)							
Dardanelles Creek - MF18.5	MF18.5	688488	4318285	Falls	NO	NO	No Photograph
Snyder Canyon Creek - MF19.5	MF19.5	689729	4319163	Falls	NO	NO	No Photograph
Volcano Canyon Creek - MF20.9a	MF20.9	691477	4319094	Falls	NO	NO	15
Volcano Canyon Creek - MF20.9b	MF20.9	691477	4319094	Falls	Potential	NO	15
Volcano Canyon Creek - MF 20.9d	MF20.9	691477	4319094	Falls	NO	NO	16
Volcano Canyon Creek - MF20.9e	MF20.9	691477	4319094	Chute	Potential	Potential	17
Volcano Canyon Creek -MF20.9f	MF20.9	691477	4319094	Falls	Potential	NO	17
North Fork of the Middle Fork American River - MF24.1	MF24.1	695149	4320344	No Barrier	YES	YES	18

¹Abbreviation: MF = Middle Fork American River

²Universal Transverse Mercator Zone 10 North, North American Datum 1983

³Minnows include hardhead, Sacramento pikeminnow, and Sacramento sucker. Distribution was assumed to be limited to the Middle Fork American River downstream of Middle Fork Interbay and the Rubicon River downstream of the impassable barrier at river mile 15.3

Barrier Photographs

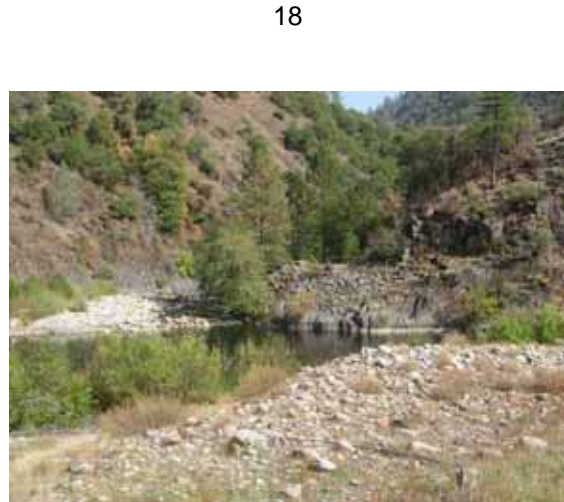

Barriers to Fish Passage – Tributary Confluences and Reservoir Pool Inlets (continued)

Barrier Characteristics

Barrier Identification	River Mile ¹	Location (UTM) ²		Barrier Class	Passable		Photograph
		Easting	Northing		Trout	Minnows ³	
Middle Fork American River from Ralston Afterbay to Middle Fork Interbay							
Ralston Afterbay - MF25.9	MF25.9	696459	4319884	No Barrier	YES	YES	19
Brushy Canyon Creek - MF30.4	MF30.4	702383	4321592	Cascade	NO	NA	20
Middle Fork American River Upstream of Middle Fork Interbay							
Middle Fork Interbay - MF36.0	MF36.0	708192	4322344	No Barrier	YES	NA	21
Duncan Creek - MF39.7a	MF39.7	712459	4323934	Chute	Potential	NA	22

¹Abbreviation: MF = Middle Fork American River

²Universal Transverse Mercator Zone 10 North, North American Datum 1983

³Minnows include hardhead, Sacramento pikeminnow, and Sacramento sucker. Distribution was assumed to be limited to the Middle Fork American River downstream of Middle Fork Interbay and the Rubicon River downstream of the impassable barrier at river mile 15.3

Barrier Photographs

19



20



21



22



Barriers to Fish Passage – Tributary Confluences and Reservoir Pool Inlets (continued)

Barrier Characteristics

Barrier Identification	River Mile ¹	Location (UTM) ²		Barrier Class	Passable		Photograph
		Easting	Northing		Trout	Minnows ³	
Middle Fork American River Upstream of Middle Fork Interbay (continued)							
Duncan Creek - MF39.7b	D0.0	712459	4323934	Falls	NO	NA	23
French Meadows Reservoir	MF51.6	724039	4334659	No Barrier	YES	NA	24
Rubicon River							
Ralston Afterbay	R0.7	697130	4319170	No Barrier	YES	YES	No Photograph
Long Canyon Creek - R3.6a	R3.6	700400	4318437	No Barrier	YES	YES	25
Long Canyon Creek - R3.6b ⁴	LC0.2	700400	4318437	Falls	NO	NO	26

¹Abbreviation: D=Duncan Creek, MF = Middle Fork American River; R = Rubicon; LC = Long Canyon Creek

²Universal Transverse Mercator Zone 10 North, North American Datum 1983

³Minnows include hardhead, Sacramento pikeminnow, and Sacramento sucker. Distribution was assumed to be limited to the Middle Fork American River downstream of Middle Fork Interbay and the Rubicon River downstream of the impassable barrier at river mile 15.3

⁴Barrier 0.2 miles upstream from confluence

Barrier Photographs

23



24



25



26



Barriers to Fish Passage – Tributary Confluences and Reservoir Pool Inlets (continued)

Barrier Characteristics

Barrier Identification	River Mile ¹	Location (UTM) ²		Barrier Class	Passable		Photograph
		Easting	Northing		Trout	Minnows ³	
Rubicon River (continued)							
Pilot Creek - R5.2a	R5.2	700746	4316083	No Barrier	YES	YES	No Photograph
Pilot Creek - R5.2b	R5.2	700746	4316083	Falls	Potential	NO	27
Pilot Creek - R5.2c	R5.2	700746	4316083	Falls	NO	NO	27
Pilot Creek - R5.2d	R5.2	700746	4316083	Falls	NO	NO	28
Pilot Creek - R5.2e	R5.2	700746	4316083	Chute	Potential	Potential	28
Pilot Creek - R5.2f	R5.2	700746	4316083	Falls	NO	NO	28
South Fork Rubicon River - R22.6	R22.6	719225	4316448	Falls	NO	NA	29
Hell Hole Reservoir Inlet - R34.5a	R34.5	727562	4329698	Chute	YES	NA	30
Hell Hole Reservoir Inlet - R34.5b	R34.5	727562	4329698	Chute	YES	NA	30
Hell Hole Reservoir Inlet - R34.5c	R34.5	727562	4329698	Falls	NO	NA	30

¹Abbreviation: R = Rubicon

²Universal Transverse Mercator Zone 10 North, North American Datum 1983

³Minnows include hardhead, Sacramento pikeminnow, and Sacramento sucker. Distribution was assumed to be limited to the Middle Fork American River downstream of Middle Fork Interbay and the Rubicon River downstream of the impassable barrier at river mile 15.3

Barrier Photographs

27



28



29



30



Barriers to Fish Passage – Tributary Confluences and Reservoir Pool Inlets (continued)

Barrier Characteristics

Barrier Identification	River Mile ¹	Location (UTM) ²		Barrier Class	Passable		Photograph
		Easting	Northing		Trout	Minnows ³	
Rubicon River (continued)							
Hell Hole Reservoir Inlet - R35.0	R35.0	728296	4329466	Critical Riffle	YES	NA	31
Hell Hole Reservoir Inlet - R35.2a	R35.2	728726	4329320	Chute	Potential	NA	32
Hell Hole Reservoir Inlet - R35.2b	R35.2	728726	4329320	Chute	Potential	NA	33
Hell Hole Reservoir Inlet - R35.8a	R35.8	729398	4328972	Falls	NO	NA	34

¹Abbreviation: R = Rubicon

²Universal Transverse Mercator Zone 10 North, North American Datum 1983

³Minnows include hardhead, Sacramento pikeminnow, and Sacramento sucker. Distribution was assumed to be limited to the Middle Fork American River downstream of Middle Fork Interbay and the Rubicon River downstream of the impassable barrier at river mile 15.3

Barrier Photographs

31



32



33



34



Barriers to Fish Passage – Tributary Confluences and Reservoir Pool Inlets (continued)

Barrier Characteristics

Barrier Identification	River Mile ¹	Location (UTM) ²		Barrier Class	Passable		Photograph
		Easting	Northing		Trout	Minnows ³	
Rubicon River (continued)							
Hell Hole Reservoir Inlet - R35.8b	R35.8	729398	4328972	Falls	NO	NA	35
Five Lakes Creek - R35.7	R35.7	729365	4329061	Critical Riffle	YES	NA	36

¹Abbreviation: R = Rubicon, 5L = Five Lakes Creek

²Universal Transverse Mercator Zone 10 North, North American Datum 1983

³Minnows include hardhead, Sacramento pikeminnow, and Sacramento sucker. Distribution was assumed to be limited to the Middle Fork American River downstream of Middle Fork Interbay and the Rubicon River downstream of the impassable barrier at river mile 15.3

Barrier Photographs

35



36



Barriers to Fish Passage – Tributary Confluences and Reservoir Pool Inlets (continued)

Barrier Characteristics

Barrier Identification	River Mile ¹	Location (UTM) ²		Barrier Class	Passable		Photograph
		Easting	Northing		Trout	Minnows ³	
Rubicon River (continued)							
Five Lakes Creek - 5L.0.2a	5L0.2	729698	4329091	Chute	Potential	NA	37
Five Lakes Creek - 5L.0.2b	5L0.2	729698	4329091	Chute	YES	NA	37
Five Lakes Creek - 5L.0.2c	5L0.2	729698	4329091	Chute	YES	NA	37
Long Canyon Creek							
Wallace Canyon	LC5.6	707907	4317350	Falls	NO	NA	No Photograph
North and South Forks Long Canyon Creek	LC11.4	715085	4322064	No Barrier	YES	NA	No Photograph
North Fork Long Canyon Creek							
North Fork Long Canyon Diversion Pool	NFLC3.1	717976	4325495	Critical Riffle	YES	NA	38

¹Abbreviation: 5L = Five Lakes Creek, LC = Long Canyon Creek, NFLC = North Fork Long Canyon Creek

²Universal Transverse Mercator Zone 10 North, North American Datum 1983

³Minnows include hardhead, Sacramento pikeminnow, and Sacramento sucker. Distribution was assumed to be limited to the Middle Fork American River downstream of Middle Fork Interbay and the Rubicon River downstream of the impassable barrier at river mile 15.3

Barrier Photographs

37



38



Barriers to Fish Passage – Tributary Confluences and Reservoir Pool Inlets (continued)

Barrier Characteristics

Barrier Identification	River Mile ¹	Location (UTM) ²		Barrier Class	Passable		Photograph
		Easting	Northing		Trout	Minnows ³	
South Fork Long Canyon Creek							
South Fork Long Canyon Diversion Pool Inlet - SFLC3.3	SFLC3.3	718898	4325542	Critical Riffle	Potential	NA	39
Duncan Creek							
Duncan Diversion Pool Inflow	D8.7	717753	4334749	No Barrier	YES	NA	40
North Fork American River							
Middle Fork American River	NF21.0	670141	4309220	No Barrier	YES	NA	41

¹Abbreviation: SFLC = South Fork Long Canyon Creek, D = Duncan Creek, NF= North Fork American River

²Universal Transverse Mercator Zone 10 North, North American Datum 1983

³Minnows include hardhead, Sacramento pikeminnow, and Sacramento sucker. Distribution was assumed to be limited to the Middle Fork American River downstream of Middle Fork Interbay and the Rubicon River downstream of the impassable barrier at river mile 15.3

Barrier Photographs

39



40



41



Barriers to Fish Passage – Natural Instream Barriers

Barrier Characteristics

Barrier Identification	River Mile ¹	Location (UTM) ²		Barrier Class	Passable		Photograph
		Easting	Northing		Trout	Minnows ³	
Middle Fork American River Downstream of Ralston Afterbay							
Ruck-a-Chucky Falls - MF10.7a	MF10.7	681367	4313756	Falls	NO	NO	1
Ruck-a-Chucky Falls - MF10.7b	MF10.7	681367	4313756	Falls	NO	NO	1
Ruck-a-Chucky Falls - MF10.7c	MF10.7	681367	4313756	Falls	NO	NO	1
Ruck-a-Chucky Falls - MF10.7d	MF10.7	681367	4313756	Falls	NO	NO	1
Ruck-a-Chucky Falls - MF10.7e	MF10.7	681367	4313756	Falls	NO	NO	1
Ruck-a-Chucky Falls - MF10.7f	MF10.7	681367	4313756	Falls	NO	NO	1
Ruck-a-Chucky Falls - MF10.7g	MF10.7	681367	4313756	Falls	NO	NO	1

¹Abbreviation: MF = Middle Fork American River

²Universal Transverse Mercator Zone 10 North, North American Datum 1983

³Minnows include hardhead, Sacramento pikeminnow, and Sacramento sucker. Distribution was assumed to be limited to the Middle Fork American River downstream of Middle Fork Interbay and the Rubicon River downstream of the impassable barrier at river mile 15.3

Barrier Photographs

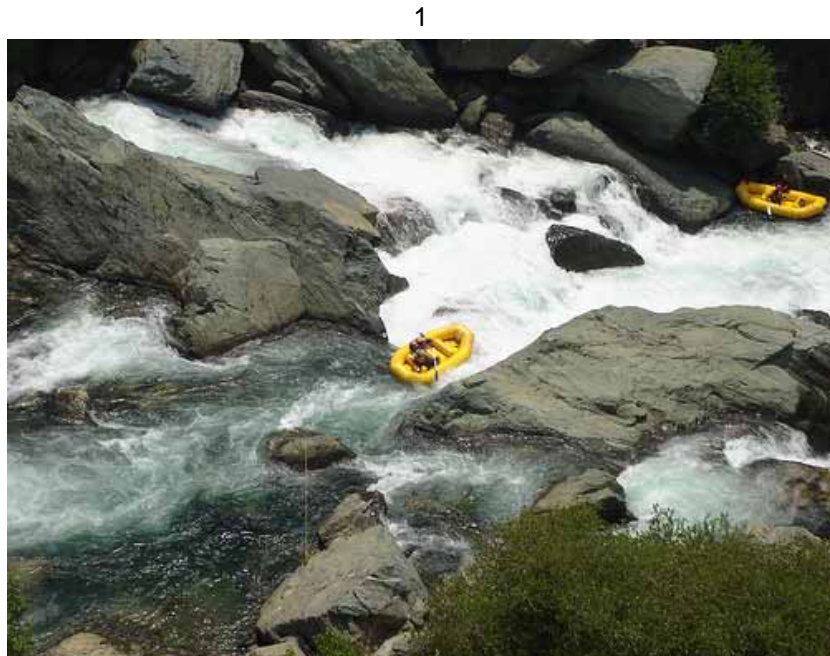
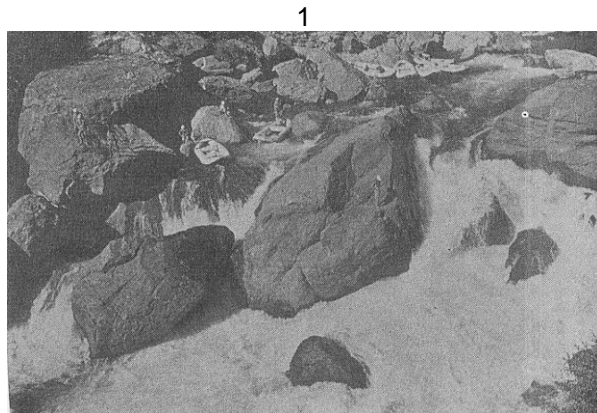
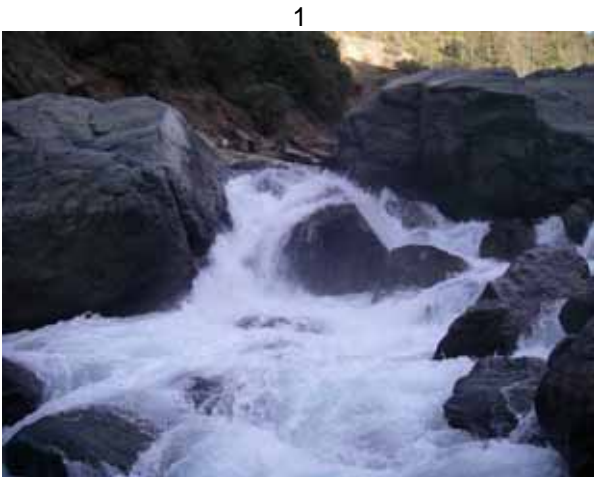

Barriers to Fish Passage – Natural Instream Barriers (continued)

Barrier Characteristics

Barrier Identification	River Mile ¹	Location (UTM) ²		Barrier Class	Passable		Photograph
		Easting	Northing		Trout	Minnows ³	
Middle Fork American River Downstream of Ralston Afterbay (continued)							
Tunnel Chute - MF22.9b	MF22.9	693788	4319854	Falls	NO	NO	2
Tunnel Chute - MF22.9e	MF22.9	693788	4319854	Falls	NO	NO	3
Middle Fork American River from Ralston Afterbay to Middle Fork Interbay							
Plunge pool above Ralston Afterbay - MF26.4	MF26.4	696791	4320336	Falls	NO	NO	4

¹Abbreviation: MF = Middle Fork American River

²Universal Transverse Mercator Zone 10 North, North American Datum 1983

³Minnows include hardhead, Sacramento pikeminnow, and Sacramento sucker. Distribution was assumed to be limited to the Middle Fork American River downstream of Middle Fork Interbay and the Rubicon River downstream of the impassable barrier at river mile 15.3

Barrier Photographs

2



3



4



Barriers to Fish Passage – Natural Instream Barriers (continued)

Barrier Characteristics

Barrier Identification	River Mile ¹	Location (UTM) ²		Barrier Class	Passable		Photograph
		Easting	Northing		Trout	Minnows ³	
Middle Fork American River Upstream of Middle Fork Interbay (continued)							
Plunge Pool above Middle Fork Interbay - MF36.3	MF36.3	708416	4322621	Falls	NO	NA	5
Instream Barrier - MF44.6	MF44.6	716448	4329510	Falls	NO	NA	No Photograph
Instream Barrier - MF44.7	MF44.7	716562	4329683	Falls	NO	NA	No Photograph
Instream Barrier - MF44.8	MF44.8	716569	4329873	Falls	NO	NA	No Photograph
Instream Barrier - MF44.9a	MF44.9	716634	4329959	Falls	NO	NA	No Photograph
Instream Barrier - MF44.9b	MF44.9	716646	4329972	Falls	NO	NA	No Photograph
Instream Barrier - MF45.2a	MF45.2	716809	4330351	Falls	NO	NA	6
Instream Barrier - MF45.2b	MF45.2	716797	4330433	Falls	NO	NA	7
Instream Barrier - MF45.3	MF45.3	716799	4330451	Falls	NO	NA	8
Instream Barrier - MF45.4	MF45.4	716961	4330701	Falls	NO	NA	No Photograph

¹Abbreviation: MF = Middle Fork American River

²Universal Transverse Mercator Zone 10 North, North American Datum 1983

³Minnows include hardhead, Sacramento pikeminnow, and Sacramento sucker. Distribution was assumed to be limited to the Middle Fork American River downstream of Middle Fork Interbay and the Rubicon River downstream of the impassable barrier at river mile 15.3

Barrier Photographs



Barriers to Fish Passage – Natural Instream Barriers (continued)

Barrier Characteristics

Barrier Identification	River Mile ¹	Location (UTM) ²		Barrier Class	Passable		Photograph
		Easting	Northing		Trout	Minnows ³	
Middle Fork American River Upstream of Middle Fork Interbay (continued)							
Instream Barrier – MF57.9	MF57.9	728358	4341168	Falls	NO	NA	9
Rubicon River							
Cascade below Long Canyon Confluence - R3.4a	R3.4	700006	4317937	Falls	NO	NO	10
Cascade below Long Canyon Confluence - R3.4b	R3.4	700006	4317937	Falls	Potential	NO	10
Instream Barrier - R6.0 ⁴	R6.0	701324	4315234	Falls	NO	NO	11
Instream Barrier - R8.2 ⁴	R8.2	703773	4313558	Falls	NO	NO	12

¹Abbreviation: R = Rubicon River

²Universal Transverse Mercator Zone 10 North, North American Datum 1983

³Minnows include hardhead, Sacramento pikeminnow, and Sacramento sucker. Distribution was assumed to be limited to the Middle Fork American River downstream of Middle Fork Interbay and the Rubicon River downstream of the impassable barrier at river mile 15.3

⁴Surveyed from the ground and from helicopter fly-overs

Barrier Photographs

9



10



11



12



Barriers to Fish Passage – Natural Instream Barriers (continued)

Barrier Characteristics

Barrier Identification	River Mile ¹	Location (UTM) ²		Barrier Class	Passable		Photograph
		Easting	Northing		Trout	Minnows ³	
Rubicon River (continued)							
Instream Barrier - R15.0a	R15.0	711660	4310265	Chute	Potential	NA	13
Instream Barrier - R15.0b	R15.0	711712	4310242	Falls	NO	NA	14
Instream Barrier - R35.8c	R35.8	729415	4328907	Falls	NO	NA	15
Instream Barrier - R35.8d	R35.8	729415	4328907	Chute	NO	NA	15
Instream Barrier - R35.8e	R35.8	729415	4328907	Falls	NO	NA	15

¹Abbreviation: R = Rubicon River

²Universal Transverse Mercator Zone 10 North, North American Datum 1983

³Minnows include hardhead, Sacramento pikeminnow, and Sacramento sucker. Distribution was assumed to be limited to the Middle Fork American River downstream of Middle Fork Interbay and the Rubicon River downstream of the impassable barrier at river mile 15.3

Barrier Photographs

13



14



15



Barriers to Fish Passage – Natural Instream Barriers (continued)

Barrier Characteristics

Barrier Identification	River Mile ¹	Location (UTM) ²		Barrier Class	Passable		Photograph
		Easting	Northing		Trout	Minnows ³	
Long Canyon Creek							
Instream Barrier - LC0.2b	LC0.2	700425	4318486	Falls	NO	NO	No Photograph
Instream Barrier - LC0.2c	LC0.2	700425	4318486	Falls	NO	NO	16
Instream Barrier - LC6.0	LC6.0	708448	4317678	Falls	NO	NA	No Photograph
Instream Barrier - LC6.2	LC6.2	708709	4317766	Falls	NO	NA	No Photograph
Instream Barrier - LC6.4	LC6.4	709082	4317838	Falls	NO	NA	No Photograph
Instream Barrier - LC6.5	LC6.5	709116	4317844	Falls	NO	NA	No Photograph
Instream Barrier - LC6.7	LC6.7	709480	4317919	Falls	NO	NA	17

¹Abbreviation: LC = Long Canyon Creek

²Universal Transverse Mercator Zone 10 North, North American Datum 1983

³Minnows include hardhead, Sacramento pikeminnow, and Sacramento sucker. Distribution was assumed to be limited to the Middle Fork American River downstream of Middle Fork Interbay and the Rubicon River downstream of the impassable barrier at river mile 15.3

Barrier Photographs

16



17



Barriers to Fish Passage – Natural Instream Barriers (continued)

Barrier Characteristics

Barrier Identification	River Mile ¹	Location (UTM) ²		Barrier Class	Passable		Photograph
		Easting	Northing		Trout	Minnows ³	
Long Canyon Creek (continued)							
Instream Barrier - LC6.8	LC6.8	709578	4318008	Falls	NO	NA	18
Instream Barrier - LC6.9a	LC6.9	709671	4318049	Falls	NO	NA	19
Instream Barrier - LC6.9b	LC6.9	709767	4318056	Falls	NO	NA	20
Instream Barrier - LC8.2a	LC8.2	711293	4319193	Falls	NO	NA	21

¹Abbreviation: LC = Long Canyon Creek

²Universal Transverse Mercator Zone 10 North, North American Datum 1983

³Minnows include hardhead, Sacramento pikeminnow, and Sacramento sucker. Distribution was assumed to be limited to the Middle Fork American River downstream of Middle Fork Interbay and the Rubicon River downstream of the impassable barrier at river mile 15.3

Barrier Photographs

18



19



20



21



Barriers to Fish Passage – Natural Instream Barriers (continued)

Barrier Characteristics

Barrier Identification	River Mile ¹	Location (UTM) ²		Barrier Class	Passable		Photograph
		Easting	Northing		Trout	Minnows ³	
Long Canyon Creek (continued)							
Instream Barrier - LC8.2b	LC8.2	711293	4319193	Falls	NO	NA	22
Instream Barrier - LC9.1a	LC9.1	712358	4319722	Falls	NO	NA	No Photograph
Instream Barrier - LC9.1b	LC9.1	712363	4319724	Falls	NO	NA	No Photograph
Instream Barrier - LC9.8	LC9.8	713247	4320390	Falls	NO	NA	No Photograph
Instream Barrier - LC11.0	LC11.0	714449	4321691	Falls	NO	NA	23
Instream Barrier - LC11.2a	LC11.2	714826	4321850	Chute	NO	NA	24
Instream Barrier - LC11.2b	LC11.2	714840	4321863	Falls	NO	NA	No Photograph
Instream Barrier - LC11.4	LC11.4	715011	4322020	Falls	NO	NA	No Photograph

¹Abbreviation: LC =Long Canyon Creek

²Universal Transverse Mercator Zone 10 North, North American Datum 1983

³Minnows include hardhead, Sacramento pikeminnow, and Sacramento sucker. Distribution was assumed to be limited to the Middle Fork American River downstream of Middle Fork Interbay and the Rubicon River downstream of the impassable barrier at river mile 15.3

Barrier Photographs

22



23



24



Barriers to Fish Passage – Natural Instream Barriers (continued)

Barrier Characteristics

Barrier Identification	River Mile ¹	Location (UTM) ²		Barrier Class	Passable		Photograph
		Easting	Northing		Trout	Minnows ³	
North Fork Long Canyon Creek							
Instream Barrier - NFLC0.1	NFLC0.1	715027	4322285	Falls	NO	NA	No Photograph
Instream Barrier - NFLC0.6	NFLC0.6	715156	4322961	Falls	NO	NA	No Photograph
Instream Barrier - NFLC0.7	NFLC0.7	715226	4323167	Falls	NO	NA	No Photograph
Instream Barrier - NFLC0.9	NFLC0.9	715347	4323376	Falls	NO	NA	No Photograph
Instream Barrier - NFLC1.6	NFLC1.6	716053	4324201	Falls	NO	NA	No Photograph
Instream Barrier - NFLC1.7	NFLC1.7	716231	4324248	Falls	Potential	NA	No Photograph
Instream Barrier - NFLC4.0	NFLC4.0	718750	4326499	Falls	NO	NA	No Photograph

¹Abbreviation: NFLC = North Fork Long Canyon Creek

²Universal Transverse Mercator Zone 10 North, North American Datum 1983

³Minnows include hardhead, Sacramento pikeminnow, and Sacramento sucker. Distribution was assumed to be limited to the Middle Fork American River downstream of Middle Fork Interbay and the Rubicon River downstream of the impassable barrier at river mile 15.3

Barriers to Fish Passage – Natural Instream Barriers (continued)

Barrier Characteristics

Barrier Identification	River Mile ¹	Location (UTM) ²		Barrier Class	Passable		Photograph
		Easting	Northing		Trout	Minnows ³	
South Fork Long Canyon Creek							
Instream Barrier - SFLC0.7	SFLC0.7	716113	4322571	Falls	NO	NA	No Photograph
Instream Barrier - SFLC0.8	SFLC0.8	716145	4322604	Chute	NO	NA	No Photograph
Instream Barrier - SFLC1.4a	SFLC1.4	716897	4323261	Falls	Potential	NA	No Photograph
Instream Barrier - SFLC1.4b	SFLC1.4	716897	4323261	Falls	Potential	NA	No Photograph
Plunge Pool below South Fork Long Canyon Diversion Dam - SFLC3.2a	SFLC3.2	718715	4325377	Chute	NO	NA	25
Plunge Pool below South Fork Long Canyon Diversion Dam - SFLC3.2b	SFLC3.2	718715	4325377	Falls	NO	NA	26
Plunge Pool below South Fork Long Canyon Diversion Dam - SFLC3.2c	SFLC3.2	718715	4325377	Chute	NO	NA	26
Plunge Pool below South Fork Long Canyon Diversion Dam - SFLC3.2d	SFLC3.2	718715	4325377	Falls	Potential	NA	27
Dewatered Section above South Fork Long Canyon Diversion Dam	SFLC3.6-4.0	722955	4324677	Dry	NO	NA	28

¹Abbreviation: SFLC = South Fork Long Canyon Creek

²Universal Transverse Mercator Zone 10 North, North American Datum 1983

³Minnows include hardhead, Sacramento pikeminnow, and Sacramento sucker. Distribution was assumed to be limited to the Middle Fork American River downstream of Middle Fork Interbay and the Rubicon River downstream of the impassable barrier at river mile 15.3

Barrier Photographs

25



26



27



28



Barriers to Fish Passage – Natural Instream Barriers (continued)

Barrier Characteristics

Barrier Identification	River Mile ¹	Location (UTM) ²		Barrier Class	Passable		Photograph
		Easting	Northing		Trout	Minnows ³	
Duncan Creek							
Instream Barrier - D4.4	D4.4	713828	4329912	Falls	NO	NA	No Photograph
Instream Barrier - D6.3	D6.3	715550	4332222	Falls	NO	NA	No Photograph
Instream Barrier - D6.4	D6.4	715644	4332365	Falls	Potential	NA	No Photograph
Instream Barrier - D6.8	D6.8	716060	4332768	Falls	Potential	NA	29
Instream Barrier - D7.2	D7.2	716466	4333135	Falls	Potential	NA	No Photograph
Instream Barrier - D8.2	D8.2	717224	4334357	Falls	Potential	NA	30
Instream Barrier - D8.4a	D8.4	717451	4334510	Falls	Potential	NA	31
Instream Barrier - D8.4b	D8.4	717479	4334525	Falls	Potential	NA	32
Instream Barrier - D9.0a	D9.0	718156	4334939	Falls	NO	NA	No Photograph

¹Abbreviation: D= Duncan Creek

²Universal Transverse Mercator Zone 10 North, North American Datum 1983

³Minnows include hardhead, Sacramento pikeminnow, and Sacramento sucker. Distribution was assumed to be limited to the Middle Fork American River downstream of Middle Fork Interbay and the Rubicon River downstream of the impassable barrier at river mile 15.3

Barrier Photographs

29



30



31



32



Barriers to Fish Passage – Natural Instream Barriers (continued)

Barrier Characteristics

Barrier Identification	River Mile ¹	Location (UTM) ²		Barrier Class	Passable		Photograph
		Easting	Northing		Trout	Minnows ³	
Duncan Creek (continued)							
Bedrock section above Duncan Diversion Dam - D9.0b	D9.0	718171	4335094	Chute	Potential	NA	33
Bedrock section above Duncan Diversion Dam - D9.1a	D9.1	718150	4335148	Chute	Potential	NA	34
Bedrock section above Duncan Diversion Dam - D9.1b	D9.1	718150	4335148	Falls	NO	NA	34

¹Abbreviation: D= Duncan Creek

²Universal Transverse Mercator Zone 10 North, North American Datum 1983

³Minnows include hardhead, Sacramento pikeminnow, and Sacramento sucker. Distribution was assumed to be limited to the Middle Fork American River downstream of Middle Fork Interbay and the Rubicon River downstream of the impassable barrier at river mile 15.3

Barrier Photographs

33



34



34



Barriers to Fish Passage – Barriers Assessed from Low Altitude Helicopter Survey

Barrier Characteristics

Barrier Identification	River Mile ¹	Location (UTM) ²		Barrier Class	Passable		Photograph
		Easting	Northing		Trout	Minnows ³	
Middle Fork American River from Ralston Afterbay to Middle Fork Interbay							
Instream Barrier Qual - MF26.6a	MF26.6	696959	4320557	Falls	NO	NO	1
Instream Barrier Qual - MF26.6b	MF26.6	696959	4320557	Falls	NO	NO	2
Instream Barrier Qual - MF26.6c	MF26.6	696959	4320557	Falls	NO	NO	3
Instream Barrier Qual - MF26.6d	MF26.6	696959	4320557	Falls	Potential	NO	4

¹Abbreviation: MF = Middle Fork American River

²Universal Transverse Mercator Zone 10 North, North American Datum 1983

³Minnows include hardhead, Sacramento pikeminnow, and Sacramento sucker. Distribution was assumed to be limited to the Middle Fork American River downstream of Middle Fork Interbay and the Rubicon River downstream of the impassable barrier at river mile 15.3

Barrier Photographs

1



2



3



4



Barriers to Fish Passage – Barriers Assessed from Low Altitude Helicopter Survey (continued)

Barrier Characteristics

Barrier Identification	River Mile ¹	Location (UTM) ²		Barrier Class	Passable		Photograph
		Easting	Northing		Trout	Minnows ³	
Middle Fork American River from Ralston Afterbay to Middle Fork Interbay (continued)							
Instream Barrier Qual - MF26.6e	MF26.6	696959	4320557	Falls	Potential	NO	5
Rubicon River							
Instream Barrier Qual - R3.9	R3.9	700514	4317912	Falls	Potential	Potential	6
Instream Barrier Qual - R4.2	R4.2	700496	4317514	Falls	Potential	Potential	7
Instream Barrier Qual - R4.5	R4.5	700727	4317090	Falls	Potential	Potential	8

¹Abbreviation: MF= Middle Fork American River, R = Rubicon River

²Universal Transverse Mercator Zone 10 North, North American Datum 1983

³Minnows include hardhead, Sacramento pikeminnow, and Sacramento sucker. Distribution was assumed to be limited to the Middle Fork American River downstream of Middle Fork Interbay and the Rubicon River downstream of the impassable barrier at river mile 15.3

Barrier Photographs

5



6



7



8



Barriers to Fish Passage – Barriers Assessed from Low Altitude Helicopter Survey (continued)

Barrier Characteristics

Barrier Identification	River Mile ¹	Location (UTM) ²		Barrier Class	Passable		Photograph
		Easting	Northing		Trout	Minnows ³	
Rubicon River (continued)							
Instream Barrier Qual - R4.6	R4.6	700905	4316927	Falls	Potential	Potential	9
Instream Barrier Qual - R4.7	R4.7	700912	4316800	Falls	Potential	Potential	10
Instream Barrier Qual - R5.1	R5.1	700728	4316285	Falls	Potential	Potential	11
Instream Barrier Qual - R6.0 ⁴	R6.0	701324	4315253	Falls	NO	NO	12

¹Abbreviation: R = Rubicon River

²Universal Transverse Mercator Zone 10 North, North American Datum 1983

³Minnows include hardhead, Sacramento pikeminnow, and Sacramento sucker. Distribution was assumed to be limited to the Middle Fork American River downstream of Middle Fork Interbay and the Rubicon River downstream of the impassable barrier at river mile 15.3

⁴Surveyed from the ground and from helicopter fly-overs

Barrier Photographs

9



10



11



12

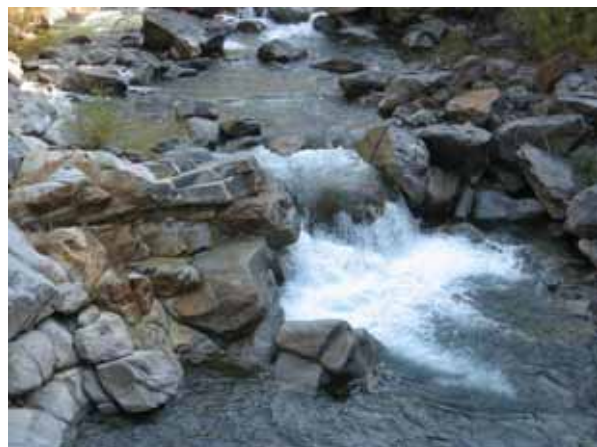

Barriers to Fish Passage – Barriers Assessed from Low Altitude Helicopter Survey (continued)

Barrier Characteristics

Barrier Identification	River Mile ¹	Location (UTM) ²		Barrier Class	Passable		Photograph
		Easting	Northing		Trout	Minnows ³	
Rubicon River (continued)							
Instream Barrier Qual - R6.1	R6.1	701467	4315256	Falls	Potential	Potential	13
Instream Barrier Qual - R7.7b	R7.7	703219	4313731	Falls	Potential	Potential	14
Instream Barrier Qual - R7.8	R7.8	703272	4313640	Falls	Potential	Potential	15
Instream Barrier Qual - R7.9	R7.9	703447	4313690	Chute	Potential	Potential	16

¹Abbreviation: R = Rubicon River

²Universal Transverse Mercator Zone 10 North, North American Datum 1983

³Minnows include hardhead, Sacramento pikeminnow, and Sacramento sucker. Distribution was assumed to be limited to the Middle Fork American River downstream of Middle Fork Interbay and the Rubicon River downstream of the impassable barrier at river mile 15.3

Barrier Photographs

13



14



15



16



Barriers to Fish Passage – Barriers Assessed from Low Altitude Helicopter Survey (continued)

Barrier Characteristics

Barrier Identification	River Mile ¹	Location (UTM) ²		Barrier Class	Passable		Photograph
		Easting	Northing		Trout	Minnows ³	
Rubicon River (continued)							
Instream Barrier Qual - R8.0	R8.0	703502	4313738	Falls	Potential	Potential	17
Instream Barrier Qual - R8.2 ⁴	R8.2	703773	4313558	Falls	NO	NO	18
Instream Barrier Qual - R8.7	R8.7	704451	4313250	Falls	Potential	NA	19
Instream Barrier Qual - R8.8	R8.8	704565	4313261	Falls	Potential	NA	20

¹Abbreviation: R = Rubicon River

²Universal Transverse Mercator Zone 10 North, North American Datum 1983

³Minnows include hardhead, Sacramento pikeminnow, and Sacramento sucker. Distribution was assumed to be limited to the Middle Fork American River downstream of Middle Fork Interbay and the Rubicon River downstream of the impassable barrier at river mile 15.3

⁴Surveyed from the ground and from helicopter fly-overs

Barrier Photographs

17

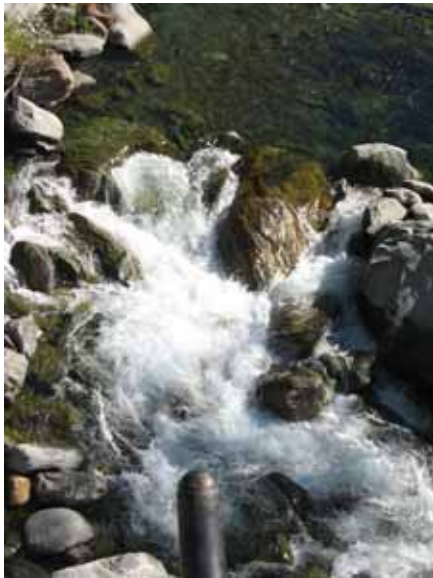

18



19



20



Barriers to Fish Passage – Barriers Assessed from Low Altitude Helicopter Survey (continued)

Barrier Characteristics

Barrier Identification	River Mile ¹	Location (UTM) ²		Barrier Class	Passable		Photograph
		Easting	Northing		Trout	Minnows ³	
Rubicon River (continued)							
Instream Barrier Qual - R8.9	R8.9	704756	4313191	Falls	Potential	NA	21
Instream Barrier Qual - R9.7	R9.7	705913	4313306	Falls	Potential	NA	22
Instream Barrier Qual - R9.8	R9.8	705972	4313246	Falls	Potential	NA	23
Instream Barrier Qual - R10.2	R10.2	706567	4313121	Falls	Potential	NA	24

¹Abbreviation: R = Rubicon River

²Universal Transverse Mercator Zone 10 North, North American Datum 1983

³Minnows include hardhead, Sacramento pikeminnow, and Sacramento sucker. Distribution was assumed to be limited to the Middle Fork American River downstream of Middle Fork Interbay and the Rubicon River downstream of the impassable barrier at river mile 15.3

Barrier Photographs

21



22



23



24



Barriers to Fish Passage – Barriers Assessed from Low Altitude Helicopter Survey (continued)

Barrier Characteristics

Barrier Identification	River Mile ¹	Location (UTM) ²		Barrier Class	Passable		Photograph
		Easting	Northing		Trout	Minnows ³	
Rubicon River (continued)							
Instream Barrier Qual - R10.7	R10.7	707200	4312745	Falls	Potential	NA	25
Instream Barrier Qual - R10.8	R10.8	707258	4312581	Falls	Potential	NA	26
Instream Barrier Qual - R11.2a	R11.2	707600	4312208	Falls	Potential	NA I	27
Instream Barrier Qual - R11.2b	R11.2	707653	4312216	Falls	Potential	NA	28

¹Abbreviation: R = Rubicon River

²Universal Transverse Mercator Zone 10 North, North American Datum 1983

³Minnows include hardhead, Sacramento pikeminnow, and Sacramento sucker. Distribution was assumed to be limited to the Middle Fork American River downstream of Middle Fork Interbay and the Rubicon River downstream of the impassable barrier at river mile 15.3

Barrier Photographs

25



26



27



28



Barriers to Fish Passage – Barriers Assessed from Low Altitude Helicopter Survey (continued)

Barrier Characteristics

Barrier Identification	River Mile ¹	Location (UTM) ²		Barrier Class	Passable		Photograph
		Easting	Northing		Trout	Minnows ³	
Rubicon River (continued)							
Instream Barrier Qual - R11.8	R11.8	708457	4312479	Falls	Potential	NA	29
Instream Barrier Qual - R12.2	R12.2	708694	4311945	Falls	Potential	NA	30
Instream Barrier Qual - R12.6	R12.6	709204	4311738	Falls	Potential	NA	31
Instream Barrier Qual - R13.0	R13.0	709240	4311086	Falls	Potential	NA	32

¹Abbreviation: R = Rubicon River

²Universal Transverse Mercator Zone 10 North, North American Datum 1983

³Minnows include hardhead, Sacramento pikeminnow, and Sacramento sucker. Distribution was assumed to be limited to the Middle Fork American River downstream of Middle Fork Interbay and the Rubicon River downstream of the impassable barrier at river mile 15.3

Barrier Photographs

29



30



31



32



Barriers to Fish Passage – Barriers Assessed from Low Altitude Helicopter Survey (continued)

Barrier Characteristics

Barrier Identification	River Mile ¹	Location (UTM) ²		Barrier Class	Passable		Photograph
		Easting	Northing		Trout	Minnows ³	
Rubicon River (continued)							
Instream Barrier Qual - R13.2	R13.2	709340	4310931	Falls	Potential	NA	33
Instream Barrier Qual - R14.6	R14.6	711068	4310035	Falls	Potential	NA	34
Instream Barrier Qual - R14.9	R14.9	711557	4310202	Falls	Potential	NA	35
Instream Barrier Qual - R15.3	R15.3	711956	4310434	Chute	NO	NA	36

¹Abbreviation: R = Rubicon River

²Universal Transverse Mercator Zone 10 North, North American Datum 1983

³Minnows include hardhead, Sacramento pikeminnow, and Sacramento sucker. Distribution was assumed to be limited to the Middle Fork American River downstream of Middle Fork Interbay and the Rubicon River downstream of the impassable barrier at river mile 15.3

Barrier Photographs

33



34



35



36



Barriers to Fish Passage – Barriers Assessed from Low Altitude Helicopter Survey (continued)

Barrier Characteristics

Barrier Identification	River Mile ¹	Location (UTM) ²		Barrier Class	Passable		Photograph
		Easting	Northing		Trout	Minnows ³	
Rubicon River (continued)							
Sedimentation from Dam Failure Event - R28.9	R28.9	722955	4324677	Dry	NO	NA	37

¹Abbreviation: R = Rubicon River

²Universal Transverse Mercator Zone 10 North, North American Datum 1983

³Minnows include hardhead, Sacramento pikeminnow, and Sacramento sucker. Distribution was assumed to be limited to the Middle Fork American River downstream of Middle Fork Interbay and the Rubicon River downstream of the impassable barrier at river mile 15.3

Barrier Photographs

37



APPENDIX D
Gradient Plots for each of the Project Rivers

AQ 6 Appendix D Figure 6-1. Middle Fork American River Gradient.

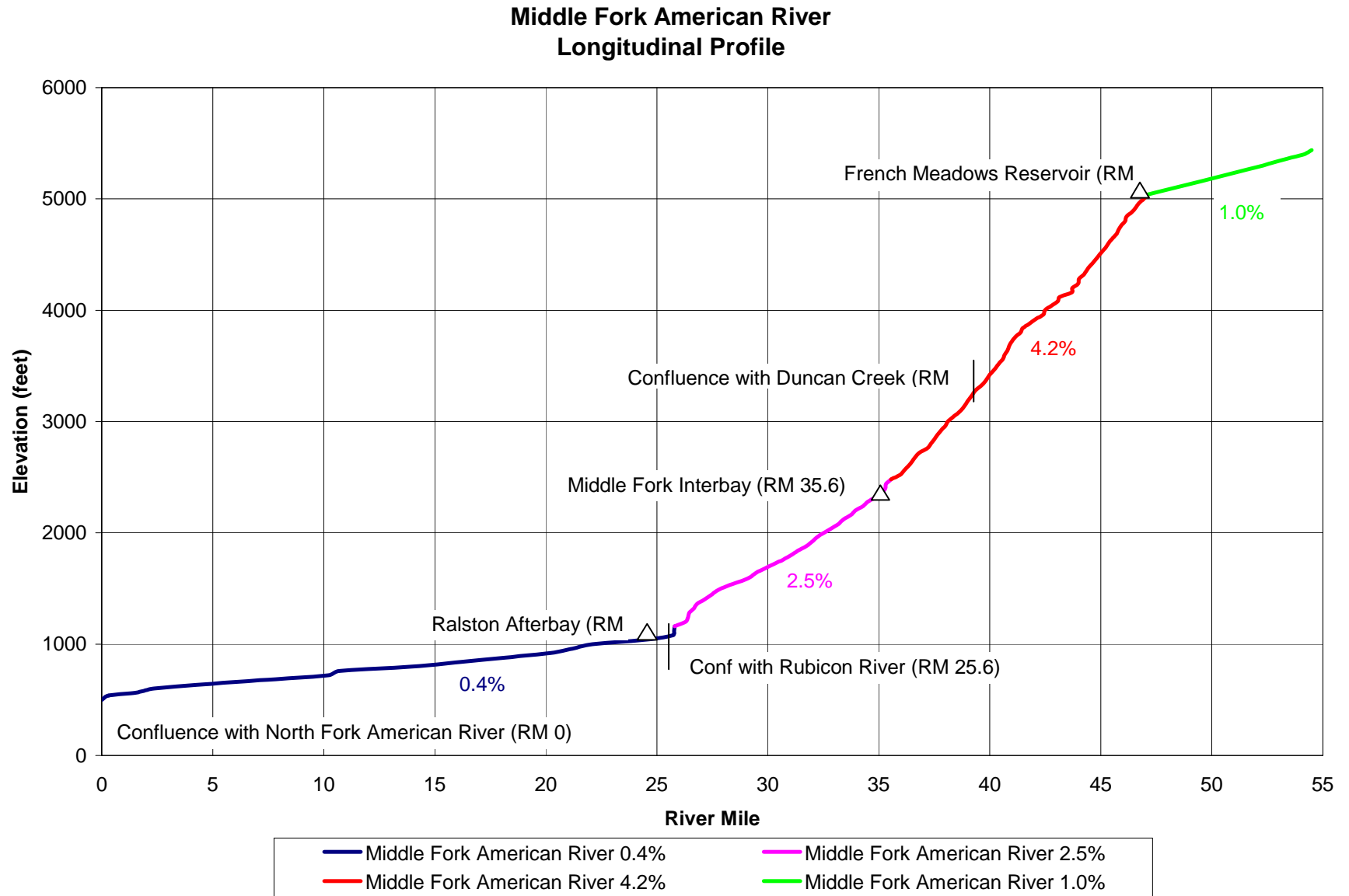

AQ 6 Appendix D Figure 6-2. Rubicon River Gradient.

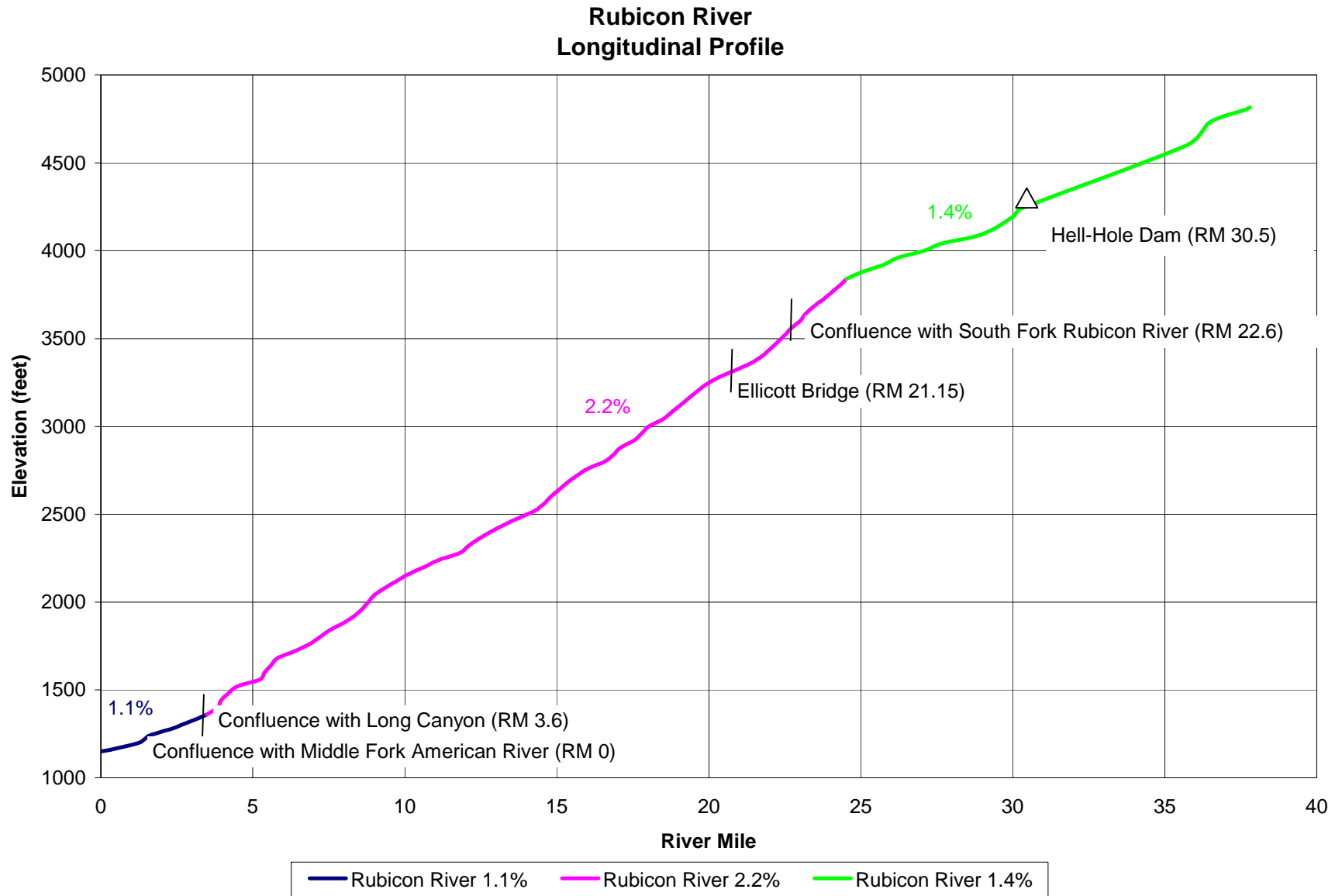

AQ 6 Appendix D Figure 6-3. Long Canyon Gradient.

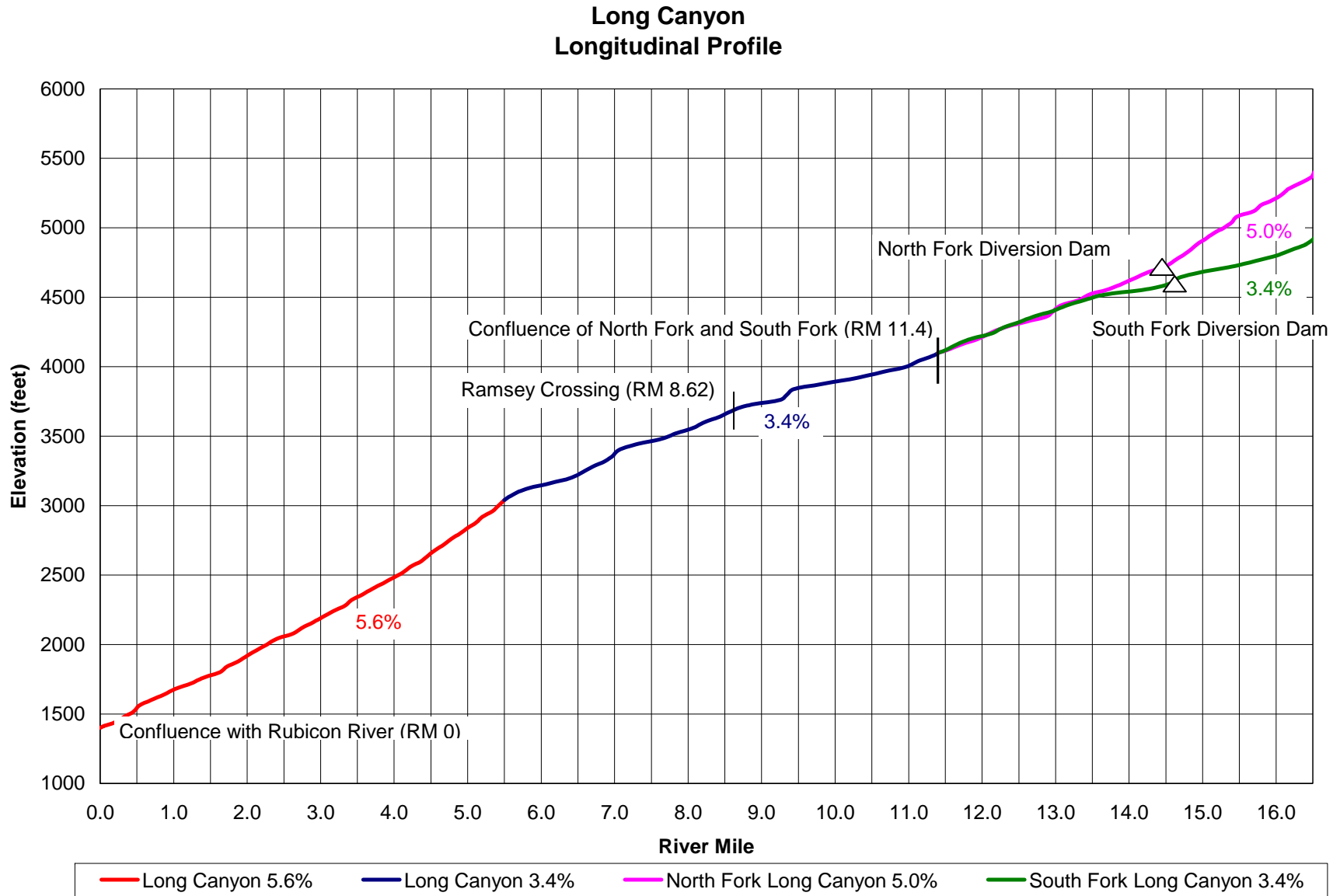

AQ 6 Appendix D Figure 6-4. Duncan Creek Gradient.

